

# Nikon

En

Nikon Close-up Speedlight Commander Kit

# R1C1

Nikon Close-up Speedlight Remote Kit

# R1

Wireless Speedlight Commander

# SU-800

Wireless Remote Speedlight

# SB-R200

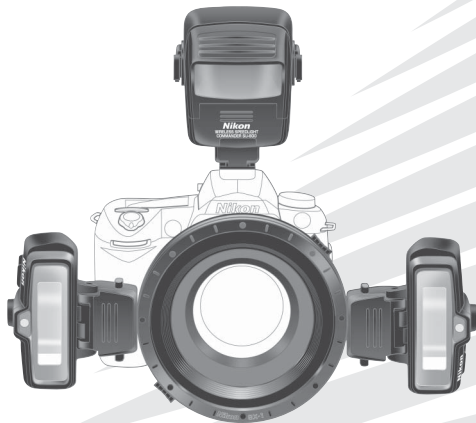

CE

User's Manual

# For your safety

Before using your product, please read the following safety precautions carefully and thoroughly to ensure correct and safe use and to help prevent damage to your Nikon product or injury to yourself or others. For quick reference by those who use the product, please keep these safety instructions near the product.

In this manual, safety instructions are indicated with these symbols:

 **WARNING** Disregarding instructions marked with this symbol could result in personal injury, or death and property damage.

 **CAUTION** Disregarding instructions marked with this symbol could result in property damage.

## **WARNINGS for the Wireless Speedlight Commander SU-800 and the Wireless Remote Speedlight SB-R200**

---

- 1 If corrosive liquids seep from the batteries and get in your eyes, immediately wash your eyes with running water and consult with a doctor.** Your eyes could be seriously damaged if they are not treated quickly.
- 2 If corrosive liquids seep from the batteries and come in contact with your skin or clothes, wash immediately with running water.** Prolonged contact could injure your skin.
- 3 Never attempt to disassemble or repair the flash unit by yourself,** as this could result in you receiving an electric shock and could also cause the unit to malfunction; such malfunction could lead to personal injury.
- 4 If the flash unit is dropped and damaged, do not touch any exposed interior metal parts.** Such parts, especially the speedlight's capacitor and associated parts, could be in a high-charge state and if touched could cause an electric shock. Disconnect the power or remove the batteries and be sure that you do not touch any of the product's electrical components, and then bring the flash unit to your local Nikon dealer or authorized service center for repair.
- 5 If you detect heat, smoke or notice a burning smell, immediately stop operation and remove the batteries** to prevent the unit from catching on fire or melting. Allow the flash unit to cool down so that you can safely touch it and remove the batteries. Then bring the unit to your local Nikon dealer or authorized service center for repair.

**6 The flash unit should never be submerged in liquid or exposed to rain, saltwater or moisture unless it is properly protected from the liquids and moisture. Underwater use requires a certified underwater housing.**

If water or moisture gets inside the unit, this could cause the unit to catch on fire or cause an electric shock. In such instances you should immediately remove the batteries from the speedlight and then bring the unit to your local Nikon dealer or authorized service center for repair.

*Note: electronic devices that are penetrated by water or moisture are often not economically repairable.*

**7 Do not use the unit in the presence of flammable or explosive gas.**

If the flash unit is operated in areas where there is a flammable gas, including propane, gasoline and dust, it could cause an explosion or fire.

**8 Do not fire the flash unit directly at the driver of a moving car,** as this could temporarily impair the driver's vision and cause an accident.

**9 Do not fire the flash unit directly into the eyes of someone that is at close range,** as it could damage their eyes' retinas. Never fire the flash unit closer than 1 meter from infants.

**10 Do not fire the unit while the flash head is touching a person or object.**

Such use can result in the person being burned, and/or their clothes igniting from the heat of the flash's firing.

**11 Keep small accessories out of the reach of children** to avoid the possibility of the accessory being swallowed. If an accessory is accidentally swallowed, immediately consult with a doctor.

**12 Use only the batteries specified in this user's manual.** Batteries other than those specified could leak corrosive liquids, explode or catch on fire or otherwise not perform satisfactorily.

**13 Non-rechargeable batteries such as manganese, alkaline-manganese and lithium batteries should never be charged in a battery charger** because they could leak corrosive liquids, explode or catch on fire.

### Symbol for separate collection applicable in European countries



This symbol indicates that this product is to be collected separately. The following apply only to users in European countries.

- This product is designated for separate collection at an appropriate collection point. Do not dispose of as household waste.
- For more information, contact the retailer or the local authorities in charge of waste management.

### CAUTIONS for the Wireless Speedlight Commander SU-800 and the Wireless Remote Speedlight SB-R200

---

- 1 Do not touch the flash unit with wet hands**, as this could cause an electric shock.
- 2 Keep the flash unit away from children to prevent them from putting the unit in or near their mouth, or otherwise touching a dangerous part of the product**; as such contact could cause an electric shock.
- 3 Do not apply strong physical shocks to the unit**, as this could cause a malfunction that could cause the unit to explode or catch on fire.
- 4 Never use active agents that contain flammable substances such as paint thinner, benzene or paint remover to clean the unit, and never store the unit in locations containing chemicals such as camphor and naphthalene**, as this could damage the plastic case, cause a fire or cause an electric shock.
- 5 Remove any batteries from the unit before storing the unit for a long time** to prevent the unit from catching on fire or leaking corrosive liquids.
- 6 Do not point the Commander SU-800's commander transmit window directly into the eyes of someone at close range**, as this can cause serious eye damage.
- 7 Do not exceed the maximum number of continuous firings**, as this may cause the flash head to overheat and can result in burns and damage to the flash panel and body.

### WARNINGS for Lithium Batteries

---

- 1 Never heat or throw batteries into a fire**, as this could cause the batteries to leak corrosive liquids, generate heat or explode.
- 2 Do not short-circuit or disassemble the batteries** because this could cause the batteries to leak corrosive liquids, generate heat or explode.
- 3 Do not install batteries in the reverse direction as this could cause the batteries to leak corrosive liquids, generate heat or explode.**
- 4 Do not carry or store batteries along with metallic materials such as necklaces and hair pins** because such materials could cause the batteries to short-circuit, leading to battery leakage, heat generation or an explosion. **In addition, specially when carrying a quantity of batteries, place them carefully in a storage case that prevents the battery terminals from touching another battery's terminals** because if they touch in reverse order it could also cause the batteries to short-circuit, leading to battery leakage, heat generation or an explosion.
- 5 If corrosive liquids seep from the batteries and get in your eyes, immediately wash your eyes with running water and consult with a doctor.** Your eyes could be seriously damaged if they are not treated quickly.

- 6 If corrosive liquids seep from the batteries and come in contact with your skin or clothes, wash immediately with running water.** Prolonged contact could injure your skin.
- 7 Always follow the warnings and instructions printed on the batteries** to avoid activities that could cause the batteries to leak corrosive liquids, generate heat or catch on fire.
- 8 Be sure to use only batteries specified in this user's manual,** to avoid the possibility of batteries leaking corrosive liquids, generating heat or exploding.
- 9 Never open the casing surrounding batteries or use batteries whose casing has been breached** as such batteries could leak corrosive liquids, generate heat or explode.
- 10 Keep batteries out of the reach of children** to help avoid the possibility of them being swallowed. If a battery is accidentally swallowed, immediately consult with a doctor.
- 11 Batteries should not be submerged in water, exposed to rain, moisture or saltwater unless they are properly protected from the wet environment.** If water or moisture gets inside the batteries, this could cause them to leak corrosive liquids or generate heat.
- 12 Do not use any battery that appears abnormal in any way, including a change in color or shape.** Such batteries could leak corrosive liquids or generate heat.
- 13 When recycling or disposing of batteries, be sure to insulate their terminals with tape.** If the battery's positive and negative terminals shortcircuit after coming into contact with metallic objects, it could cause fire, heat generation or an explosion. Dispose of used batteries in accordance with local government regulations.
- 14 Non-rechargeable batteries should never be charged in a battery charger** because they could leak corrosive liquids or generate heat.
- 15 Remove dead batteries from your equipment immediately,** as they could leak corrosive liquids, generate heat or explode.

## CAUTIONS for Lithium Batteries

---

- 1 Do not throw or apply strong physical shocks to the batteries** as this could cause batteries to leak corrosive liquids, generate heat or explode.
- 2 Be careful when replacing batteries after continuous flash use,** because batteries may generate heat during continuous flash photography.

## WARNING for TTL Cord SC-30

---

**Never attempt to disassemble or repair the cord by yourself,** as this could result in an electric shock and could also cause the unit to malfunction, which could lead to injury.

# Foreword

Thank you for purchasing the Nikon Wireless Speedlight system. To get the most out of your Speedlight system, please read this user's manual thoroughly before use. Also read "Close-up Speedlight Photography Examples," a separate booklet that provides an overview of Speedlight flash-shooting capabilities and contains photographic examples. Keep your camera and Speedlight user's manuals handy for quick reference.

## **Main features and functions**

---

This Speedlight system, which features the Nikon Creative Lighting System (CLS), provides a variety of wireless multiple flash and close-up flash operations. The Speedlight system mainly consists of the Wireless Speedlight Commander SU-800, which controls flash output when mounted on CLS-compatible cameras; the Wireless Remote Speedlight SB-R200, which has a guide number of 10/33 (ISO 100, m/ft) or 14/46 (ISO 200, m/ft); and the Attachment Ring SX-1, which is used to attach the SB-R200 to the front of the lens.

- When using CLS-compatible cameras, you can divide the Speedlight units into three groups and control the flash output independently for each group.
- Wireless close-up flash operation is possible when the SU-800 is mounted on a CLS-compatible camera to control the SB-R200 (p. 65).
- The SB-R200 can be attached to the front of the lens, held in your hand, or freely positioned by using the Speedlight Stand AS-20, which comes with the unit.
- The SU-800 features a Commander function that can trigger wirelessly remote flash units such as the SB-R200 and SB-600 without firing itself (p. 79).
- Included with the kit are a variety of accessories to help you enjoy close-up flash shooting, such as the Extreme Close-Up Positioning Adapter SW-11, Color Filter Set SJ-R200, Diffuser SW-12, and Flexible Arm Clip SW-C1.
- When using the SU-800 with cameras not compatible with CLS, only close-up flash operation (using cords) is possible in use with the optional TTL Cord SC-30 (p. 109).

## Nikon Creative Lighting System (CLS)

CLS offers various flash shooting possibilities by taking advantage of the improved digital data communication capabilities of Nikon Speedlights and cameras.

The major features are as follows:

- **i-TTL Mode**

This is a TTL auto flash mode in CLS. When using the i-TTL auto flash mode, Monitor Preflashes are fired at all times. The flash output level is adjusted by measuring the flash illumination that is reflected back from the subject, resulting in an exposure that is less affected by ambient light (p. 116).

- **Advanced Wireless Lighting**

The wireless multiple flash operation in TTL (i-TTL) mode can be accomplished with CLS-compatible cameras. The remote flash units can be divided into three groups and flash output can be independently controlled for each group, expanding the range of creative multiple flash shooting techniques (p. 26).

- **Flash Value Lock**

Flash Value, or “FV,” is the amount of flash exposure for the subject. Using FV Lock with compatible cameras, you can lock in the appropriate flash exposure for the main subject. This flash exposure is locked in, even if you change the aperture or composition, or zoom the lens in and out (p. 98).

- **Auto FP High-Speed Sync**

High-Speed flash synchronization at your camera's highest shutter speed is now possible. This is useful when you want to use a wider aperture to ensure a shallow depth of field blurs the background (p. 96).

See your CLS-compatible camera user's manual for details on the Nikon Creative Lighting System (CLS).

## Life-long learning

As part of Nikon's "Life-long learning" commitment to ongoing product support and education, continually updated information is available online at the following sites:

- For users in the U.S.A.: <http://www.nikonusa.com/>
  - For users in Europe and Africa: <http://www.europe-nikon.com/support/>
  - For users in Asia, Oceania and the Middle East: <http://www.nikon-asia.com/>
- Visit these sites to keep up-to-date with the latest product information, tips, answers to frequently asked questions, and to receive general advice on digital imaging and photography. Additional information may be available from the Nikon representative in your area. See the URL below for contact information: <http://nikonimaging.com/>

### "Watch and learn!" Digitutor

[http://www.nikondigitutor.com/index\\_eng.html](http://www.nikondigitutor.com/index_eng.html)



The Nikon Digitutor website uses movies and sample photos to demonstrate the basic functions of the R1C1.

Use the Digitutor together with this manual to make the most of your R1C1.

## Notes

- **Default:** Functions and flash modes preset before being shipped from the factory are referred to as "Default" settings in this manual.
- **CLS:** Hereafter, Nikon **C**reative **L**ighting **S**ystem is abbreviated to **CLS**.
- "Cameras compatible with Nikon Creative Lighting System" are abbreviated as "CLS-compatible cameras."
- In this manual, the Wireless Speedlight Commander SU-800 is called the "Commander SU-800" or "SU-800" and the Wireless Remote Speedlight SB-R200, the "Remote Speedlight SB-R200" or "SB-R200."

### Symbols used in this manual

-  : Denotes important points to prevent malfunction or shooting failure.
-  : Useful points that should be remembered to better enjoy the Speedlight.
-  : Provides convenient reference information for using the Speedlight system.



# Contents

## Preparation

- For your safety ..... 2
- Foreword..... 6
- Tips on using the Speedlight..... 12
- Recommended cameras and lenses ..... 13
- Confirm receipt of contents in your kit..... 15
  - Available flash operations depending on each kit
  - Contents vary according to each kit
- Speedlight parts, their functions, and accessories ..... 18
  - SU-800's LCD panel and icons ..... 20
- Wireless multiple flash operation in the Nikon Creative Lighting System (CLS) ..... 26

## Flash operation using the Nikon Close-up Speedlight Commander Kit R1C1

### (Used with Nikon CLS-compatible cameras) ..... 27

- Procedures for close-up flash operation ..... 28
- Procedures for Commander flash operation ..... 38

## Flash operation using the Nikon Close-up Speedlight Remote Kit R1

### (Used with Nikon CLS-compatible cameras) ..... 45

## Functions and use of the SU-800

- SU-800's available flash operations ..... 54
- Using the SU-800 ..... 55
- Functions of the SU-800 ..... 58

## Functions and use of the SB-R200

- SB-R200's available flash operations ..... 60
- Using the SB-R200 ..... 61
- Functions of the SB-R200 ..... 64

Preparation

Flash operation using the R1C1

Flash operation using the R1

Functions and use of the SU-800

Functions and use of the SB-R200

Details on close-up flash operation and shooting procedures

Details on Commander flash operation and shooting procedures

Other functions

Flash operation using various accessories

Flash shooting using SLRs not compatible with CLS

Reference information

## **Details on close-up flash operation and shooting procedures**

### **(Used with CLS-compatible cameras)**

- Close-up flash operation ..... 66
- Overview of close-up flash operation ..... 68
- Procedures for close-up flash operation ..... 70

## **Details on Commander flash operation and shooting procedures**

### **(Used with CLS-compatible cameras)**

- Commander flash operation ..... 80
- Overview of Commander flash operation ..... 82
- Procedures for Commander flash operation ..... 84

## **Other functions**

- Test firing to confirm exposure ..... 88
- Checking illumination before taking pictures  
    (modeling illumination) ..... 89
- Using the Target Light (focus-assist illuminator) ..... 90
- Autofocus flash operation in low light ..... 91
- Flash output level compensation ..... 92
- Repeating (RPT) flash operation ..... 93
- Auto FP High-Speed Sync ..... 96
- Flash Value Lock (FV Lock) ..... 98

## **Flash operation using various accessories**

- Flash shooting with colored gel filters ..... 100
- Flash shooting with the Extreme Close-Up Positioning  
    Adapter SW-11 ..... 103
- Flash shooting with the Diffuser SW-12 and Flexible  
    Arm Clip SW-C1 ..... 105
- Flash shooting with Speedlight Stand AS-20 ..... 107

## **Flash shooting using SLR cameras not compatible with CLS**

- Overview of close-up flash operation (using cords) ..... 110
- Procedures for close-up flash operation (using cords) ... 112

## Reference information

- Available flash modes ..... 116
- Usable lenses with limited functions with the SB-R200... 120
- Notes on continuous flash operation (in close-up flash operation (using cords)) ..... 122
- Optional accessories ..... 123
- Tips on Speedlight care ..... 124
- Notes on batteries ..... 125
- Troubleshooting ..... 126
- Specifications ..... 130
- Index ..... 132

**Preparation**

**Flash operation using the R1C1**

**Flash operation using the R1**

**Functions and use of the SU-800**

**Functions and use of the SB-R200**

**Details on close-up flash operation and shooting procedures**

**Details on Commander flash operation and shooting procedures**

**Other functions**

**Flash operation using various accessories**

**Flash shooting using SLRs not compatible with CLS**

**Reference information**

# Tips on using the Speedlight

## **Take trial shots**

Take test photos before photographing important events, such as weddings and graduations.

## **Have Nikon regularly spot-check your Speedlight**

Nikon recommends that you have your Speedlight serviced by an authorized dealer or service center at least once every two years.

## **Using your Speedlight correctly**

The Nikon Speedlight's performance has been optimized for use with Nikon brand cameras and accessories, including lenses.

Camera and accessories made by other manufacturers might not meet Nikon's specification criteria, and nonconforming cameras and accessories could damage the Speedlight's components. Nikon cannot guarantee the Speedlight's performance when used with non-Nikon products.

# Recommended cameras and lenses

## Recommended cameras

### Cameras compatible with Nikon Creative Lighting System (CLS)

A variety of wireless multiple flash and close-up flash operations using the SU-800 and the SB-R200 are available with Nikon CLS-compatible cameras.

- Refer to your camera user's manual for details on available camera functions.

Usable CLS-compatible cameras: D4, D3-Series, D800-Series, D700, D2-Series, D300-Series, D200, D90, D80, D70-Series, D7000, D5100, D5000, D3200, D3100, D3000, D60, D50, D40-Series, F6, etc.

## Recommended lenses

### Micro NIKKOR lenses

Micro NIKKOR lenses provide a maximum reproduction ratio of 1:1 or 1:2. These lenses offer high optical performance that is best suited to Nikon cameras, allowing you to take texture-quality pictures anywhere from close-up to infinity.

- AF Micro-Nikkor 60mm f/2.8D
- AF-S Micro NIKKOR 60mm f/2.8G ED
- AF Micro-Nikkor 105mm f/2.8D
- AF-S VR Micro-Nikkor 105mm f/2.8G IF-ED
- AF Micro-Nikkor 200mm f/4D IF-ED
- AF-S DX Micro NIKKOR 85mm f/3.5G ED VR

**Note :** The AF Zoom-Micro Nikkor 70-180mm f/4.5-5.6D ED cannot be used with the SB-R200 attached, as the weight of the flash unit may affect accurate focusing.

### Using the Nikon D70-Series camera's Commander mode

Be sure to set the channel number of the remote flash unit(s) to 3 and set the group of the remote flash unit(s) to group A when performing wireless multiple flash with a Nikon D70-Series camera's built-in flash as a Commander, otherwise the remote flash unit(s) will not fire.

### With SLR cameras incompatible with CLS

Use the TTL Cord SC-30 (optional) to connect the SU-800 and the SB-R200 (p. 109).

### COOLPIX-Series digital cameras

When mounting the SU-800, the COOLPIX P7100/P7000/P6000 can perform wireless Commander flash operation. Set the group of remote flash unit(s) to "A" (other groups cannot be used). Set the flash mode of flash unit(s) in group A to TTL, and the master and remote flash unit(s) in groups B and C to "---" (flash cancelled).

- The SU-800 and SB-R200 cannot be used with COOLPIX-Series digital cameras other than COOLPIX P7100/P7000/P6000 (p. 126).

### Usable lenses with limited functions with the SB-R200

The maximum number of SB-R200 units that can be attached to the front of the lens and which focal lengths can be used vary depending on the lens in use. For more details, refer to "2 Usable lenses with limited functions with the SB-R200" (p. 120).

## Recommended cameras and lenses

### ❑ Lenses unusable with the SB-R200

AF NIKKOR lenses with a ring that rotates during AF operation.

### ❑ Using lenses that extend and retreat during AF operation

NIKKOR lenses that extend and retreat in length during AF operation may not autofocus correctly, or may lead to damage of the lens or camera's autofocus mechanism due to the weight of the flash head. Therefore, do not perform autofocus operation, but use manual focus instead.

### ❑ Using an AF Micro-Nikkor 60mm f/2.8D lens

- Be sure to attach the Dedicated Adapter Ring UR-5 (optional) to the AF Micro-Nikkor 60mm f/2.8D lens, then attach the SX-1 to the lens with the Adapter Ring SY-1-72.

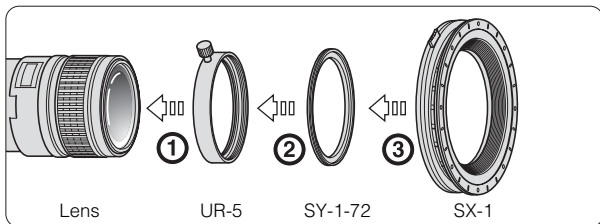

### ❑ Notes on using an AF Micro-Nikkor 105mm f/2.8D lens

Autofocus operation is possible if you attach the Attachment Ring SX-1 to the AF Micro-Nikkor 105mm f/2.8D lens using the Adapter Ring SY-1-62.

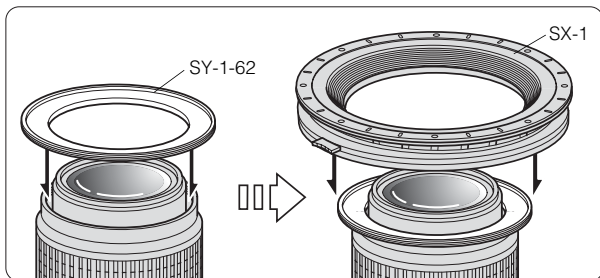

# Confirm receipt of contents in your kit

## Available flash operations depending on each kit

Available flash operation varies according to each kit. Accessories other than those included in the kit may be necessary. Refer to the table below.

Users of the Nikon Close-up Speedlight Commander Kit R1C1 should read through this user's manual.

Users of the Nikon Close-up Speedlight Remote Kit R1, Commander SU-800 and Remote Speedlight SB-R200 should read the sections necessary for each kit.

Products	Available flash operations	Usable cameras	Speedlight and Commander not included in the kit
Nikon Close-up Speedlight Commander Kit R1C1	Close-up	CLS-compatible cameras Cameras not compatible with CLS*1	—
	Commander	CLS-compatible cameras	—
Nikon Close-up Speedlight Remote Kit R1	Close-up	CLS-compatible cameras with Commander function.	—
	Commander	CLS-compatible cameras with Commander function.	SU-800, SB-910, SB-900, SB-800, SB-700
Commander SU-800	Close-up	CLS-compatible cameras Cameras not compatible with CLS*1	SB-R200
	Commander	CLS-compatible cameras	SB-R200, SB-910, SB-900, SB-800, SB-700, SB-600
Remote Speedlight SB-R200	Close-up	CLS-compatible cameras Cameras not compatible with CLS*1	SU-800
		CLS-compatible cameras with Commander function	—
	Commander	CLS-compatible cameras with Commander function.	SU-800, SB-910, SB-900, SB-800, SB-700

\*1 The optional TTL Cord SC-30 is required (p. 123).

**Note:** With CLS-compatible cameras, the TTL Cord SC-30 (optional) is not required.

# Confirm receipt of contents in your kit

## Contents vary according to each kit

Check that all items listed below are included. If any items are missing, inform the store where the kit was purchased or the seller immediately.

- The below illustrations differ in scale.

### Nikon Close-up Speedlight Commander Kit R1C1

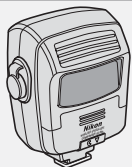

Wireless Speedlight Commander SU-800



Soft Case SS-SU800 for SU-800

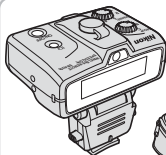

Wireless Remote Speedlight SB-R200 (x2)



IR Panel for Built-in Flash SG-3IR



Soft Case SS-R200 for SB-R200 (x2)



Flexible Arm Clip SW-C1



Speedlight Stand AS-20 (x2)

### Nikon Close-up Speedlight Remote Kit R1



Attachment Ring SX-1



Adapter Ring Set (5 rings) (x1)



Soft Case SS-SX1 for SX-1

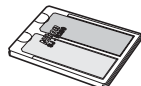

Color Filter Set SJ-R200 (for SB-R200 package) (4 filters in 4 models) (x2)



Extreme Close-Up Positioning Adapter SW-11 for SB-R200 (x2)



Color Filter Holder SZ-1 (x2)

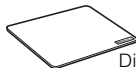

Diffuser SW-12

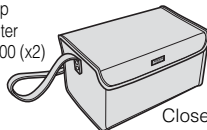

Close-up Speedlight Kit Case SS-MS1

### Commander SU-800



Wireless Speedlight Commander SU-800

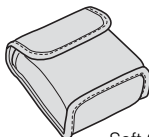

Soft Case SS-SU800 for SU-800



	Nikon Close-up Speedlight Commander Kit R1C1	Nikon Close-up Speedlight Remote Kit R1	Commander SU-800	Remote Speedlight SB-R200
Wireless Speedlight Commander SU-800	1	—	1	—
Wireless Remote Speedlight SB-R200	2	2	—	1
Attachment Ring SX-1	1	1	—	—
Adapter Ring Set	1 set (5 rings)	1 set (5 rings)	—	—
Extreme Close-Up Positioning Adapter SW-11 for SB-R200	2	2	—	—
Color Filter Holder SZ-1	2	2	—	1
Color Filter Set SJ-R200 (for SB-R200 package)	2 sets (4 models, 4 filters)	2 sets (4 models, 4 filters)	—	4 models, 4 filters
Speedlight Stand AS-20	2	2	—	1
IR Panel for Built-in Flash SG-3IR	1	1	—	—
Flexible Arm Clip SW-C1	1	1	—	—
Diffuser SW-12	1	1	—	—
Close-up Speedlight Kit Case SS-MS1	1	1	—	—
Soft Case SS-SU800 for SU-800	1	—	1	—
Soft Case SS-R200 for SB-R200	2	2	—	1
Soft Case SS-SX1 for SX-1	1	1	—	—

### Remote Speedlight SB-R200

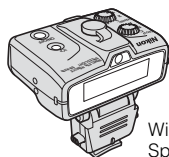

Wireless Remote  
Speedlight  
SB-R200



Soft Case SS-R200  
for SB-R200

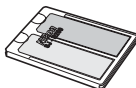

Color Filter Set SJ-R200  
(for SB-R200 package)  
(4 filters in 4 models) (x1)



Speedlight  
Stand AS-20



Color Filter  
Holder  
SZ-1

# Speedlight parts, their functions, and accessories

## ■ Wireless Speedlight Commander SU-800

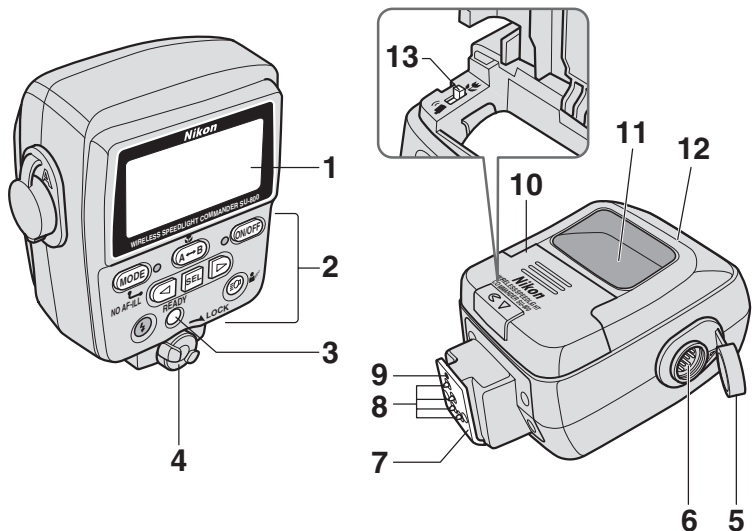

**1 LCD Panel (p. 20)**

**2 Control Buttons**

**3 Ready-light**

Lights up when the Speedlight is fully recycled and ready to fire.

**4 Mounting Foot-lock Lever (p. 29)**

**5 Terminal Cover**

**6 TTL Cord Terminal**

Connects the SU-800 with the SB-R200 when used with cameras not compatible with CLS. (p. 110)

**7 Mounting Foot (p. 29)**

**8 Hot-shoe Contacts**

**9 Mount Pin**

**10 Battery Chamber lid (p. 28)**

**11 AF-assist Illuminator**

**12 Commander Transmit Window**

**13 Commander/Close-up Select Switch**

Toggles between the close-up and Commander modes. (p. 58)

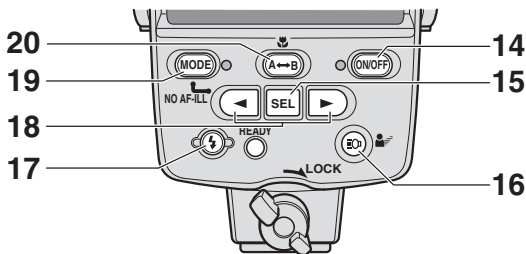

## ■ Control buttons on the SU-800

### 14 [ON/OFF] Button

Press to turn the power on or off.

To avoid accidental firing or a malfunction when carrying the SU-800 in your camera bag, turn off the flash unit.

### 15 [SEL](FUNC.) button

- Press to select the items to be set. The selected item will blink and can be changed using the [◀] and [▶] buttons.
- Press for approx. 2 sec. to display another setting.

### 16 Target Light Button

- Press to turn the Target light (focus-assist illuminator). (p. 89)
- Press for approx. 1 sec. to activate or cancel the target light. (p. 90)

### 17 Test Button

Press to test fire the flash. (p. 88)

### 18 [◀] (left) Button

### [▶] (right) Button

Press to change the values of the items or settings that are blinking.

### 19 [MODE] Button

Press to set the flash mode.

### 20 [A↔B] Select Button

In the close-up mode, press to set the flash units in groups A and B to fire or to cancel.

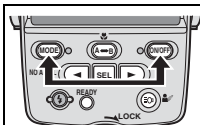

Simultaneously press the [ON/OFF] and [MODE] buttons (two-button reset) to reset all settings (selected by the Commander/Close-up select switch) to their default values. The LCD panel will blink 3 times.

## ● Using the SU-800 in low light

Press any button on the SU-800 to turn the illuminator on (when the SU-800's power is on), and it will remain lit for about 16 seconds.

- The SU-800's control button illuminator comes on when the camera's LCD panel illuminator is turned on.
- The control button illuminator goes out when the shutter is released.

# Speedlight parts, their functions, and accessories

## SU-800's LCD panel and icons

Icons on the SU-800's LCD panel show the status of the operations set. These icons vary depending on the settings and the combination of camera and flash units in use.

- The below illustrations are for reference only and may differ to the actual display.

### Icons in close-up flash operation

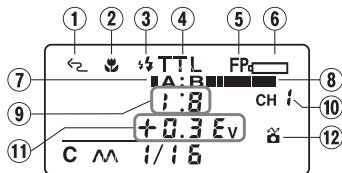

Display in TTL mode

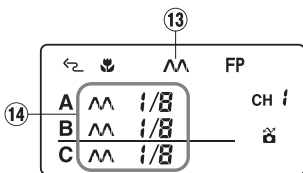

Display in M (manual) mode

- 1 Wireless Flash**  
A control signal is sent from the SU-800 to the remote flash units such as the SB-R200.
- 2 Close-up Mode**  
Close-up function is set to "activated."
- 3 Monitor Preflashes**  
Just before the flash fires, the Speedlight fires a series of imperceptible preflashes to collect necessary data for actual flash firing.
- 4 TTL Mode**  
Measuring the flash illumination reflected back from the subject, the camera automatically controls the flash output level to give the correct exposure.
- 5 Auto FP High-Speed Sync**  
Auto FP High-Speed Sync. is available when the SU-800 is connected to cameras compatible with Auto FP High-Speed Sync. (p. 96).
- 6 Low Battery-power**  
Replace the battery.
- 7 Flash Output Level (Group A)**  
Visually indicates the group A's flash output level in the TTL mode.
- 8 Flash Output Level (Group B)**  
Visually indicates the group B's flash output level in the TTL mode.
- 9 Flash Output Level Ratio (Groups A : B)**  
Indicates the flash output level ratio between groups A and B in the TTL mode.
- 10 Channel**  
Represents the communication channel number through which the SU-800 and SB-R200 exchange data.
- 11 Flash Output Level Compensation (Groups A, B)**  
Represents flash output level compensation for groups A and B in the TTL mode.
- 12 CLS-compatible camera**  
The SU-800 is connected to cameras compatible with CLS.
- 13 Manual Flash**  
The flash always fires at a specified output in combination with the aperture and light output level (guide number).
- 14 Manual Flash Output Level**  
Represents flash output level for each group in Manual flash mode.

## Icons in Commander flash operation

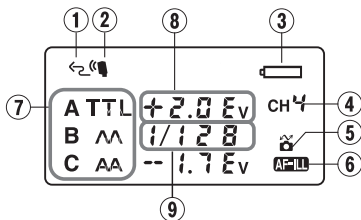

### 1 Wireless Flash

A control signal is sent from the SU-800 to the remote flash units such as the SB-R200.

### 2 Commander Mode

Commander function is activated.

### 3 Low Battery-power

Replace the battery.

### 4 Channel

Represents the communication channel number through which the Commander and Speedlight exchange data.

### 5 CLS-compatible camera

The SU-800 is connected to cameras compatible with CLS.

### 6 AF-Assist Illuminator activated

The AF-Assist Illuminator comes on. NO AF-ILL appears when the AF-Assist Illuminator is canceled (p. 91).

### 7 Group

Represents the group names and flash mode in each group.

### 8 Flash Output Level Compensation Value

Flash output level compensation value.

### 9 Manual Flash Output Level

Represents flash output level for each group in Manual flash mode.

## Icons in close-up flash operation (using cords)

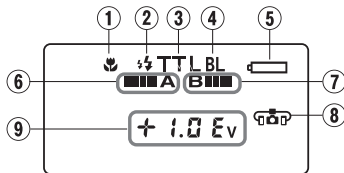

Display in TTL BL mode

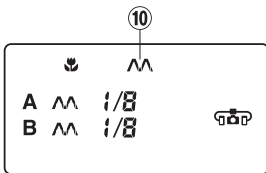

Display in M (manual) mode

### 1 Close-up Mode

Close-up function is activated.

### 2 Monitor Preflashes

Just before the flash fires, the Speedlight fires a series of imperceptible preflashes.

### 3 TTL Mode

Measuring the flash illumination reflected back from the subject, the camera automatically controls the flash output level to give the correct exposure.

### 4 Balanced Fill-Flash

The flash output level is automatically controlled for a well-balanced exposure of the main subject and background.

### 5 Low Battery-power

Replace the battery.

### 6 Flash firing (Group A)

Flash unit(s) in Group A fires in the TTL mode.

### 7 Flash firing (Group B)

Flash unit(s) in Group B fires in the TTL mode.

# Speedlight parts, their functions, and accessories

## ⑧ Using Cords

The SU-800 is connected to the SB-R200 using cords when mounted on cameras not compatible with CLS. This indicator blinks if the SB-R200 is not correctly connected.

## ⑨ Flash Output Level Compensation Value (Groups A, B)

Indicates the flash output level compensation for groups A and B in the TTL mode.

## ⑩ Manual Mode

The flash always fires at a specified output in combination with the aperture and light output level (guide number).

## Displays when blinking

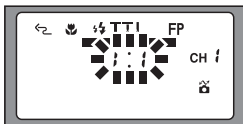

Indicate that these items can be adjusted or changed. Stop after blinking six times unless an adjustment is made.

- Icons blinking also indicate warning and errors.
- When the [ON/OFF] + [MODE] buttons are simultaneously pressed (two-button reset) for approx. 2 sec., the display blinks three times (p. 19).

## Using the SU-800 in low light

Press any button on the SU-800 to turn the illuminator on (when the SU-800's power is on), and it will remain lit for about 16 seconds.

- The SU-800's control button illuminator comes on when the camera's LCD panel illuminator is turned on.
- The control button illuminator goes out when the shutter is released.

## Characteristics of the LCD panel

- Due to the directional characteristics of LCDs, the LCD display is difficult to read when viewed from above. However, the display can be seen clearly from a somewhat lower angle.
- The LCD display becomes darker at high temperatures (approx. 60°C/140°F), but returns to normal at normal temperatures (20°C/68°F).
- The LCD's response time slows down at low temperatures (approx. 5°C/41°F and below), but returns to normal at normal temperatures (20°C/68°F).

## ■ Wireless Remote Speedlight SB-R200

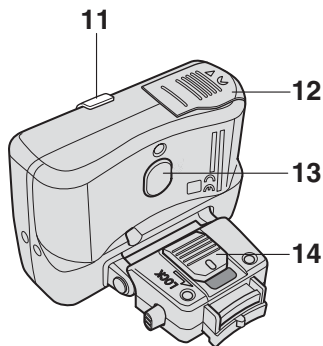
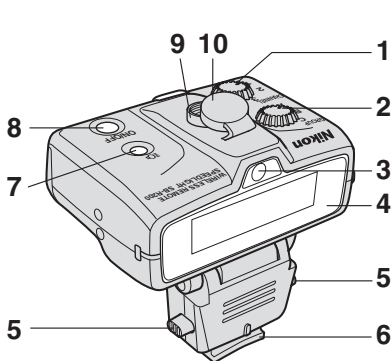

### 1 [CHANNEL] select dial

Sets the communication channel through which the Commander and SB-R200 units exchange data (p. 35).

### 2 [GROUP] select dial

Sets the group of the SB-R200 (p. 36).

### 3 Target Light (Focus-Assist Illuminator)

### 4 Flash head

### 5 Release button

Hold down and slowly move the SB-R200 until it comes to the desired position, then release the button to secure (p. 31).

### 6 Mounting Foot (p. 31)

### 7 Target Light Button

Sets the target light to turn on or off (p. 90).

### 8 [ON/OFF] button

Press to turn the power on or off.  
To avoid accidental firing or a malfunction when carrying the SB-R200 in your camera bag, turn off the flash unit.

### 9 TTL cord terminal

Connects the SU-800 to the SB-R200 via a cord when used with cameras that are not compatible with CLS (p. 110).

### 10 Terminal cover

Close the cover when not using the TTL cord.

### 11 Ready-light

The lamp lights up in green when the power is on. It turns red when the SB-R200 is fully recycled and ready to fire.  
The green lamp blinks when battery power is weak.

### 12 Battery chamber lid (p. 30)

### 13 Light sensor window for wireless remote flash

### 14 Lock switch

Secures the SB-R200 to the Attachment Ring (p. 31).

# Speedlight parts, their functions, and accessories

## ■ Attachment Ring SX-1

The SX-1 is used to secure the SB-R200 by attaching it to the Adapter Ring on the front of the lens.

The SB-R200 is detachable at any position around the Attachment Ring. You can slide the SB-R200 freely around the ring. There are click stops every 15° on the Attachment Ring.

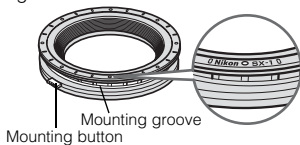

## ■ Adapter Rings (SY-1-52, SY-1-62, SY-1-67, SY-1-72, SY-1-77)

These rings can be attached to the front of the lens for mounting the Attachment Ring SX-1. Five Adapter Rings, with diameters of ø52mm, ø62mm, ø67mm ø72mm and ø77mm are provided.



## ■ Extreme Close-Up Positioning Adapter SW-11

The SW-11 can be attached to the SB-R200 and used to curve flash light toward the optical axis to create lighting effects when taking close-up shots (p. 103).

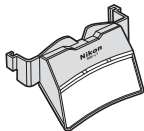

## ■ Color Filter Holder SZ-1

The SZ-1 is used to attach a colored gel filter (SJ-R200 or optional SJ-2) to the flash head of the SB-R200 (p. 102).

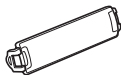

## ■ Color Filter Set SJ-R200 (for SB-R200 package)

The set comprises a total of 4 filters: the FL-G1 for fluorescent light, the TN-A1 for incandescent/tungsten light, Blue and Red (p. 100).

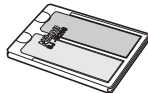

## ■ Speedlight Stand AS-20

The AS-20 can be used to freely position and steady the SB-R200. The Attachment Ring SX-1 can be attached to a tripod (p. 107).

Speedlight mounting shoe

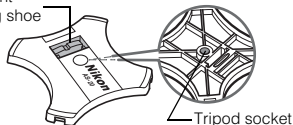

## ■ IR Panel for Built-in Flash SG-3IR

The SG-3IR can be attached to a camera's hot shoe when a Nikon digital camera's built-in flash (such as D70-Series) is used as a Commander (p. 50).

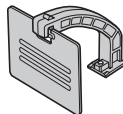

## ■ Flexible Arm Clip SW-C1

The SW-C1 can be used to hold a Diffuser. It can also be attached to the mounting groove on the Attachment Ring SX-1 (p. 105).



## ■ Diffuser SW-12

The SW-12 is a milky-white board that can be used to diffuse flash light (p. 105).

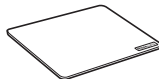



### ■ Soft Case SS-SU800 for SU-800

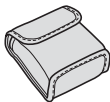

### ■ Soft Case SS-SX1 for SX-1

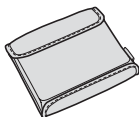

### ■ Soft Case SS-R200 for SB-R200

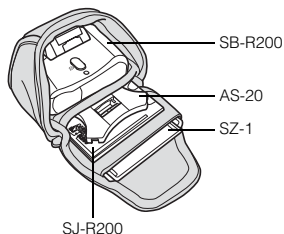

### ■ Close-up Speedlight Kit Case SS-MS1

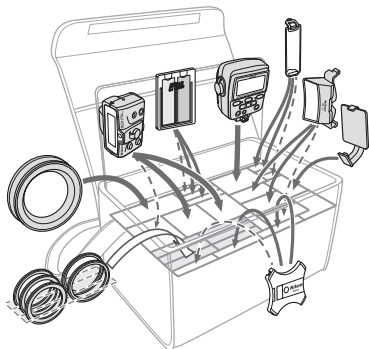
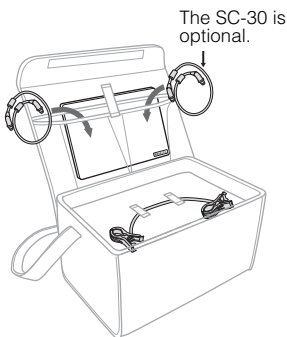
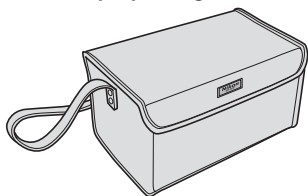

### Caring for the Close-up Speedlight Kit Case SS-MS1

- Do not clean the case with a moistened cloth. Never use organic solvent or a bleaching agent such as thinner or benzene.
- If the case gets wet, wipe it with a dry, soft cloth, and fully dry in the shade.
- Be careful not to leave the case for a long time in locations subject to high humidity or direct sunlight, otherwise the surface may become stiff, cracked, or faded in color.

# Wireless multiple flash operation in the Nikon Creative Lighting System (CLS)

When the SU-800 is used with Nikon CLS-compatible cameras, the remote flash units can be divided into a maximum of 3 groups, and the flash output level can be separately set for each group of Master/Commander and remote flash unit(s), providing wireless multiple flash operation (Advanced Wireless Lighting).

## Master flash unit and remote flash unit(s)

In this user's manual, the Commander SU-800 and Speedlight mounted on the camera, a built-in flash or the one directly connected to the camera via a TTL Cord is called the Master/Commander flash unit. All other flash units are called remote flash units.

## Details of Advanced Wireless Lighting

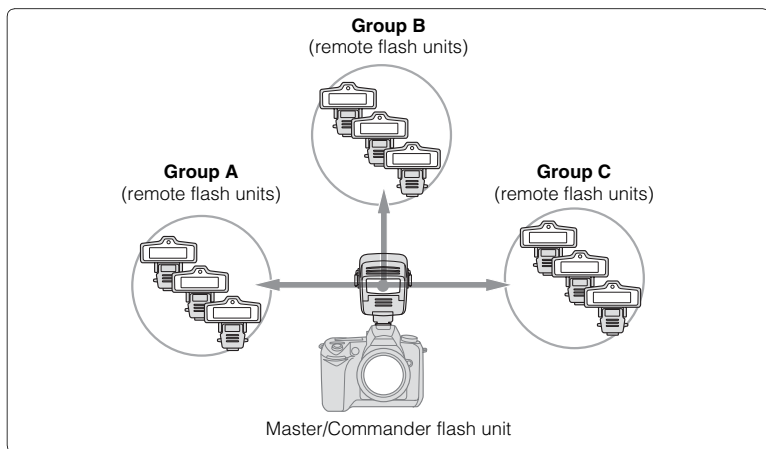

- Remote flash units can be divided into a maximum of three groups (A, B and C).
- One or more remote flash units can be set to one group.
- Flash mode and flash output-level compensation values can be set independently on the Master/Commander flash unit and for three other groups of remote flash units.
- Select one of the four available channels through which the Master/Commander flash unit and three other groups exchange data.
- If a photographer performs the same Advanced Wireless Lighting near you, your remote flash unit(s) might accidentally fire in sync with that photographer's master flash unit. If this happens, select a different channel number.

# Flash operation

## using the Nikon Close-up Speedlight Commander Kit R1C1

---

(Used with Nikon CLS-compatible cameras)

This section describes the necessary procedures for **wireless close-up** and **Commander flash operations** with a CLS-compatible camera when using the Nikon Close-up Speedlight Commander Kit R1C1.

- For details on close-up flash operation, see page 65.
- For details on Commander flash operation, see page 79.

### Procedures for close-up flash operation

---

- 1** Installing batteries in the SU-800.
- 2** Attaching the SU-800 to the camera.
- 3** Installing batteries in the SB-R200.
- 4** Attaching the SB-R200 to the front of the lens.
- 5** Turning on the camera, the SU-800 and SB-R200.
- 6** Setting the flash mode on the SU-800.
- 7** Setting a channel number on the SU-800 and SB-R200.
- 8** Setting a group on the SB-R200.
- 9** Compose a picture and shoot with flash.

### Procedures for Commander flash operation

---

- 1** Setting Commander function on the SU-800.
- 2** Setting up the SB-R200.
- 3** Turning on the camera, the SU-800 and SB-R200.
- 4** Setting the flash mode on the SU-800.
- 5** Setting a channel and a group.
- 6** Compose a picture and shoot with flash.

# Procedures for close-up flash operation



## Installing batteries in the SU-800.

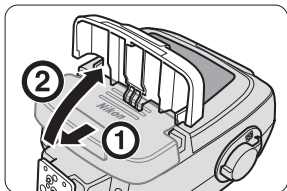

- 1** Slide open the battery chamber lid in the direction of the arrow.

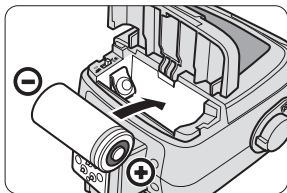

- 2** Install the battery, then close the battery chamber lid by sliding it back into place.

Use CR123A (3V) lithium batteries.

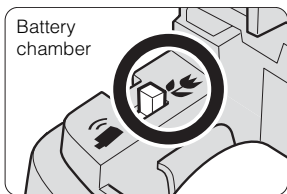

Battery chamber

### Confirming the close-up mode setting

Make sure that the Commander/Close-up select switch in the battery chamber is set to "Close-up" position.

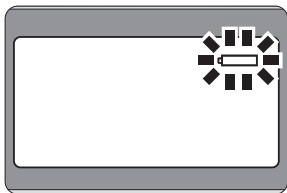

### Replacing the battery

The Low Battery-power Indicator blinks when the SU-800's ready-light does not come on within about 30 seconds of turning on the power or after the flash has fired.

- Replace the battery.

## 2

### Attaching the SU-800 to the camera.



- 1 Ensure the SU-800 and camera body are turned off.

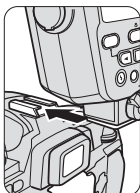

- 2 Rotate the Mounting Foot-lock lever to the left, slide the SU-800's Mounting Foot into the camera's accessory shoe and turn the lock lever to the right.

#### ☑ Mounting Foot-lock lever

To lock the Speedlight in place, turn the lock lever clockwise approx. 90° until it stops. To unlock, turn the lever counterclockwise until it stops.

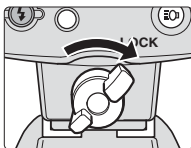

Lock

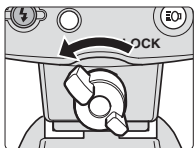

Unlock

# Procedures for close-up flash operation

3

## Installing batteries in the SB-R200.

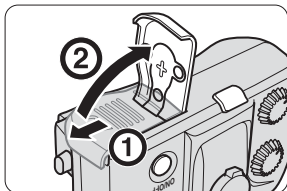

- 1** Slide open the battery chamber lid in the direction of the arrow.

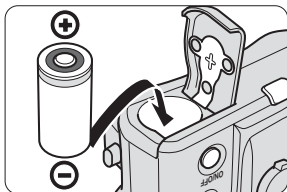

- 2** Install the battery, then close the battery chamber lid by sliding it into place.

Use CR123A (3V) lithium batteries.

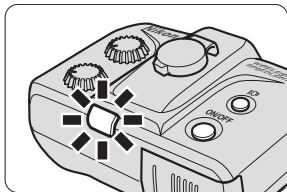

### Replacing the battery

When the SB-R200's battery power is weak, the green ready-light blinks after the power is turned on or after the flash has fired.

- Replace the battery.

4

## Attaching the SB-R200 to the front of the lens.

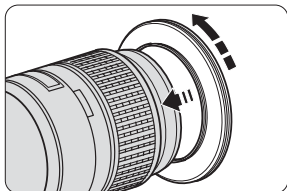

### 1 Attach one of the Adapter Rings to the front of the lens.

Five types of Adapter Rings with different diameters ( $\phi 52\text{mm}$ ,  $\phi 62\text{mm}$ ,  $\phi 67\text{mm}$ ,  $\phi 72\text{mm}$ , and  $\phi 77\text{mm}$ ) are provided.

- Turn the Adapter Ring securely until it stops.
- These rings cannot be used together with other lens filters.
- AF Micro-Nikkor 105mm f/2.8D is shown in the illustration.

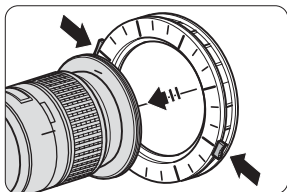

### 2 Press the Attachment Ring SX-1's Mounting Buttons on both sides to attach it to the Adapter Ring, then release.

- Make sure that the Nikon logo (p. 24) on the SX-1 is on the under side facing down.
- Use fingers of both hands to press the two Mounting Buttons on both sides to attach the SX-1 securely.
- Make sure that the SX-1 is not attached at an angle. If it is, remove and reattach.

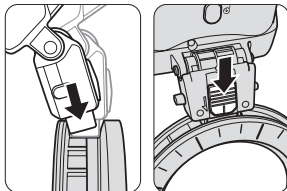

### 3 Slide the SB-R200's Mounting Foot into the SX-1's Mounting Groove, then slide the lock switch.

The Mounting Foot cannot be inserted in reverse.

- Slide the lock switch until it stops and make sure that the red part can no longer be seen.

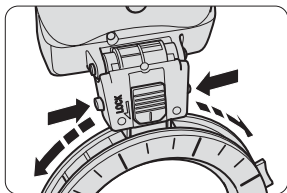

### 4 Move the SB-R200 slowly by holding down the Release Button on the SB-R200's Mounting Foot. Remove your fingers at the desired position to secure it.

There are click stops every  $15^\circ$  on the Attachment Ring.

## Procedures for close-up flash operation

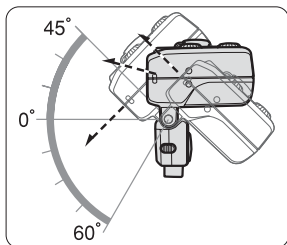

### **5 Adjust the SB-R200's flash head.**

The flash head of the SB-R200 tilts 60° toward the optical axis and 45° in the opposite direction. The flash head can be set at click stops every 15°.

### **📌 Using the SB-R200 off-lens**

Use the provided Speedlight Stand AS-20 to set up the SB-R200 at any location (p. 107).



## 5

## Turning on the camera, the SU-800 and SB-R200.

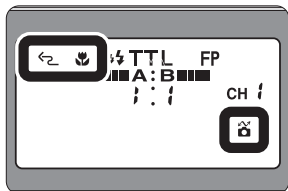
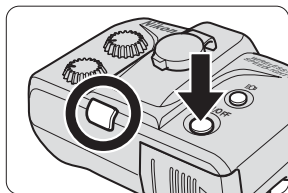
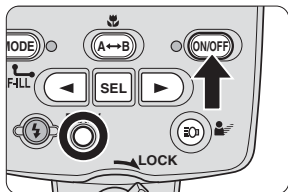

## 1 Press the [ON/OFF] buttons to turn on the camera, the SU-800 and SB-R200.

Ensure that the ready-light on the SU-800 comes on.

The ready-light on the SB-R200 lights up in green when the power is on, then turns red when the SB-R200 is fully recycled.

## 2 Check the indicators on the SU-800's LCD panel.

Confirm that Wireless flash, Close-up mode and CLS-compatible camera indicators are all displayed on the LCD panel (p. 20).

# Procedures for close-up flash operation

6

## Setting the flash mode on the SU-800.

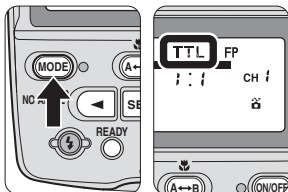

### 1 Press the [MODE] button on the SU-800 to set the flash mode to TTL.

Use of TTL mode is recommended for normal flash shooting.

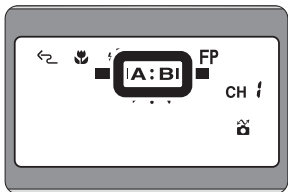

### 2 Confirm the flash settings of the SB-R200.

Ensure that both Groups A and B are displayed.

- If a Group A or B indicator does not appear, the remote flash unit(s) of this Group will not fire. Press the [A→B] select button to display both Group A and B indicators.

# 7

## Setting a channel number on the SU-800 and SB-R200.

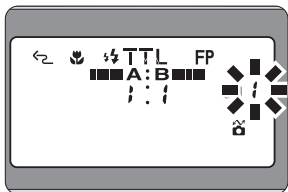

### 1 Set a channel number on the SU-800.

Press the [SEL](FUNC.) button to display channel number (blinking). Press the [◀] or [▶] button to change the channel number. Press the [SEL](FUNC.) button again and the channel number will stop blinking. The last channel number to blink is the one that has been set automatically.

- Select one of the four available channels.
- The channel number blinks during adjustment and stops after blinking six times unless an adjustment is made. The last channel number to blink is the one that has been set automatically.

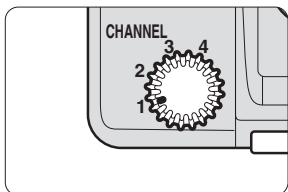

### 2 Set a channel number on the SB-R200.

Rotate the [CHANNEL] select dial on the SB-R200 to set the same channel number as set on the SU-800.

## Procedures for close-up flash operation

8

### Setting a group on the SB-R200.

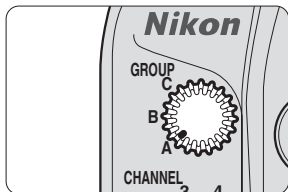

#### 1 Set a group on each SB-R200.

Rotate the [GROUP] select dial on each flash unit to set the group to A or B. Once set, the SB-R200 will operate according to the controls for each group as set on the SU-800.

## 9

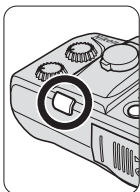
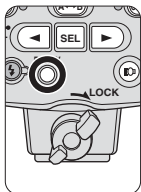
**Compose a picture and shoot with flash.****1 Compose the picture and shoot.**

Confirm that the red ready-lights on the SU-800 and SB-R200 are on then release the shutter.

- For details on test firing, refer to page 88.

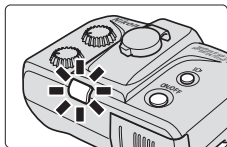
**☑ If the red ready-light blinks immediately after shooting**

In TTL mode, when the SB-R200 flash has fired at its maximum output and underexposure may have occurred, the red ready-light on the SB-R200 will blink for approx. 3 sec. (The ready-lights on the SU-800 and in the camera's viewfinder do not blink.)

To compensate, set a higher ISO sensitivity or use a wider aperture and reshoot.

# Procedures for Commander flash operation



## Setting Commander function on the SU-800.

The Commander function enables the SU-800 to act as a Commander unit to trigger remote flash unit(s) without firing itself.

- 1 Install the battery in the SU-800 in the same way as No. 1 in “Procedures for close-up flash operation.” (p. 28)**

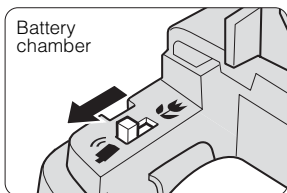

- 2 Set the Commander/Close-up select switch on the SU-800 to Commander function.**

Use the Commander/Close-up select switch to change the close-up function to Commander function or vice versa.

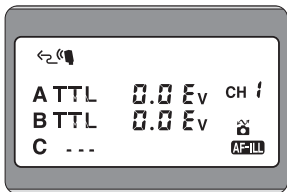

Display in Commander flash operation

- 3 Attach the SU-800 to the camera in the same way as No. 2 in “Procedures for close-up flash operation.” (p. 29)**

## 2

## Setting up the SB-R200.

- 1** Install the battery in the SB-R200 in the same way as No. 3 in “Procedures for close-up flash operation.” (p. 30)

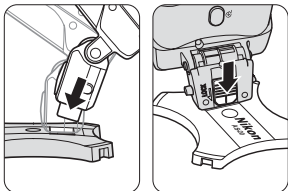

- 2** Slide the SB-R200's Mounting Foot into the AS-20's Speedlight Mounting Shoe and slide the lock switch.

The Mounting Foot cannot be inserted in reverse.

- Slide the lock switch until it stops and make sure that the red part can no longer be seen.

- 3** Set up the SB-R200.

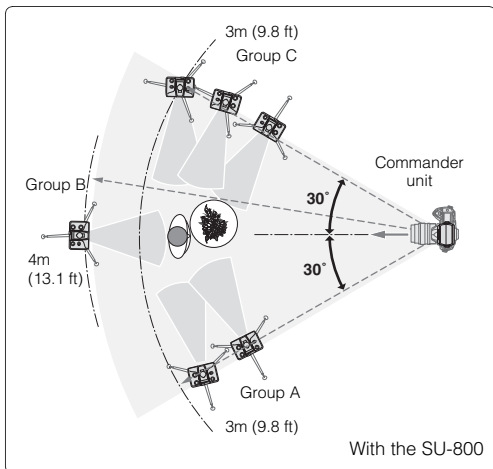

As a basic guide, the effective shooting distance between the Master/Commander unit and the SB-R200 is approx. 4m (13.1 ft) or less in the front position, and approx. 3m (9.8 ft) at both sides. These ranges vary slightly depending on conditions and/or ambient light.

- Be sure to place all SB-R200 units that are set in the same group close together.
- The set up range of the SB-R200 units vary depending on the Commander unit (camera, Speedlight, etc.) For details, see your Speedlight or camera's user's manual.
- For notes on setting up the SB-R200, see “Setting up the SB-R200” on page 108.

## Procedures for Commander flash operation

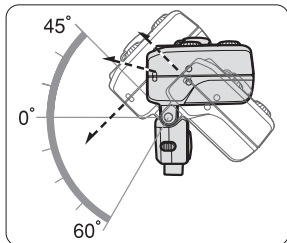

### **4 Adjust the SB-R200's flash head.**

The flash head of the SB-R200 tilts down to 60° and up to 45°. The flash head can be set at click stops every 15°.

### **Attaching the SB-R200 to the front of the lens**

---

The SB-R200 can be attached to the front of the lens through the Attachment Ring SX-1 (p. 31).



### 3

## Turning on the camera, the SU-800 and SB-R200.

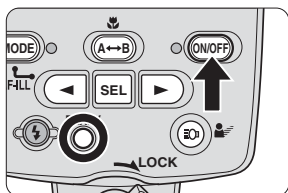

- 1 Press the [ON/OFF] buttons to turn on the camera, the SU-800 and SB-R200.**

Ensure that the red ready-lights on the SU-800 and SB-R200 come on.

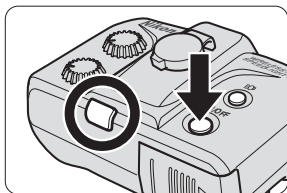

# Procedures for Commander flash operation

4

Set the remote flash unit's flash mode on the SU-800.

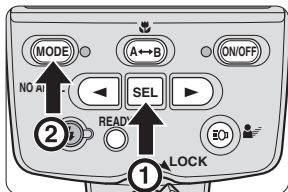

- 1 Press the [SEL](FUNC.) button to display the flash mode (blinking) of each group, then press [MODE] button to set the flash mode to TTL.

Use of TTL mode is recommended for normal flash shooting.

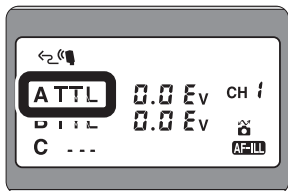



## Setting a channel number and a group on the SU-800 and SB-R200.

- 1 Set a channel number and a group on the SU-800 and SB-R200 in the same way as No. 7 and 8 in “Procedures for close-up flash operation.” (pp. 35, 36)

# Procedures for Commander flash operation

6

## Compose a picture and shoot with flash.

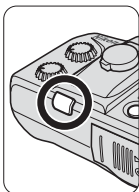
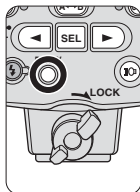

### 1 Compose the picture and shoot.

Ensure that the red ready-lights on the SU-800 and SB-R200 are on, then release the shutter.

- For details on test firing, refer to page 88.

### ✓ If the red ready-light blinks immediately after shooting

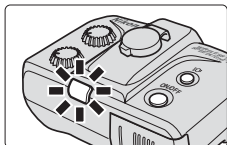

In TTL mode, when the SB-R200 flash has fired at its maximum output and underexposure may have occurred, the red ready-light on the SB-R200 will blink for approx. 3 sec. (The ready-lights on the SU-800 and in the camera's viewfinder do not blink.)

To compensate, move closer to the subject, set a higher ISO sensitivity or use a wider aperture and reshoot.

# Flash operation

## using the Nikon Close-up Speedlight Remote Kit R1

---

(Used with Nikon CLS-compatible cameras)

This section describes the necessary procedures for **wireless close-up flash operation** with CLS-compatible cameras that feature a Commander function and the Nikon Close-up Speedlight Remote Kit R1.

- For details on close-up flash operation, see page 65.

- 
- 1** Installing batteries in the SB-R200.
  - 2** Attaching the SB-R200 to the front of the lens.
  - 3** Turning on the camera and SB-R200.
  - 4** Setting the Commander function on the camera.
  - 5** Setting a channel number and group on the SB-R200.
  - 6** Compose a picture and shoot with flash.

# Flash operation using the R1



## Installing batteries in the SB-R200.

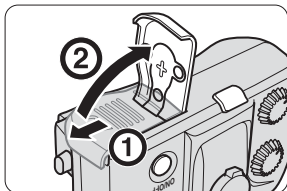

- 1** Slide open the battery chamber lid in the direction of the arrow.

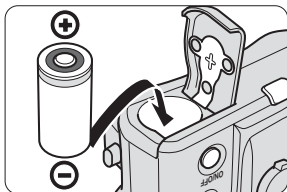

- 2** Install the battery, then close the battery chamber lid by sliding it into place.

Use CR123A (3V) lithium batteries.

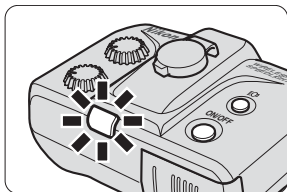

### Replacing the battery

When battery power is weak, the SB-R200's green ready-light blinks when the power is turned on or after the flash has fired.

- Replace the battery.

**2**

## Attaching the SB-R200 to the front of the lens.

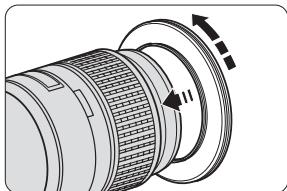

### 1 Attach one of the Adapter Rings to the front of the lens.

Five types of Adapter Rings with different diameters ( $\phi 52\text{mm}$ ,  $\phi 62\text{mm}$ ,  $\phi 67\text{mm}$ ,  $\phi 72\text{mm}$ , and  $\phi 77\text{mm}$ ) are provided.

- Turn the Adapter Ring securely until it stops.
- These rings cannot be used together with other lens filters.
- AF Micro-Nikkor 105mm f/2.8D is shown in the illustration.

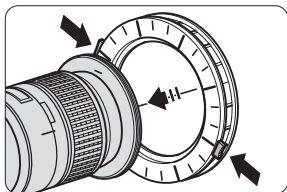

### 2 Press the Attachment Ring SX-1's Mounting Buttons on both sides to attach it to the Adapter Ring, then release.

- Make sure that the Nikon logo (p. 24) on the SX-1 is on the under side facing down.
- Use fingers of both hands to press the two Mounting Buttons on both sides to attach the SX-1 securely.
- Make sure that the SX-1 is not attached at an angle. If it is, remove and reattach.

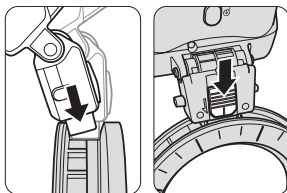

### 3 Slide the SB-R200's Mounting Foot into the SX-1's Mounting Groove as shown, then slide the lock switch.

The Mounting Foot cannot be inserted in reverse.

- Slide the lock switch until it stops and make sure that the red part can no longer be seen.

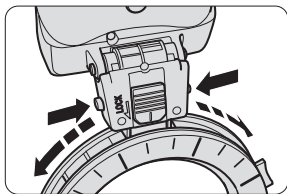

### 4 Move the SB-R200 slowly by holding down the Release Buttons on the SB-R200's Mounting Foot until it comes to the desired position. Release the Release Buttons to secure.

There are click stops every  $15^\circ$  on the Attachment Ring.

## Flash operation using the R1

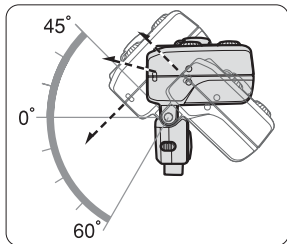

### 5 Adjust the SB-R200's flash head.

The flash head of the SB-R200 tilts 60° toward the optical axis and 45° in the opposite direction. The flash head can be set at a click stop every 15°.

### Using the SB-R200 off-lens

Use the provided AS-20 Speedlight Stand to set up the SB-R200 at any location (p. 107).



### 3

## Turning on the camera and SB-R200.

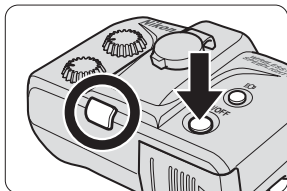

### 1 Press the [ON/OFF] buttons to turn on the camera and SB-R200.

Ensure that the red ready-lights on the camera and SB-R200 come on.

# Flash operation using the R1



## Setting the Commander function on the camera.

### 1 Set the Commander function on the camera and flash mode on the SB-R200.

- Be sure to read the user's manual of the camera in use.

### Notes on using camera's built-in flash in Commander mode

Camera	Available flash mode of built-in flash	Usable channel number	Usable group
D800-Series, D700, D300-Series, D200, D90, D80, D7000	TTL, M, -- (Flash canceled)	1 to 4	A, B
D70-Series	(Flash canceled)	3	A

### Using the IR Panel for Built-in Flash SG-3IR

Built-in flash units on cameras such as the D70-Series fire at reduced flash output levels when used as Commander units. This may slightly affect results if pictures are taken from close distances. To prevent this, use the SG-3IR.

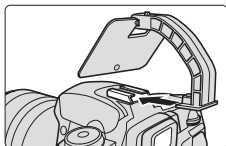

### 1 Attach the SG-3IR to the camera's accessory shoe.

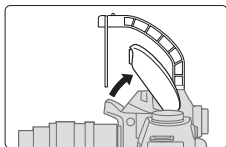

### 2 Set up the SG-3IR and the built-in flash unit as shown in the illustration.

# 5

## Setting a channel and group number on the SB-R200.

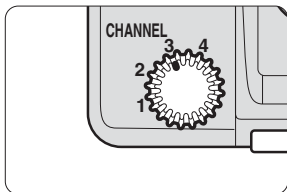

### 1 Rotate the [CHANNEL] select dial on the SB-R200 to set the channel number.

- Set the channel number of the SB-R200 to 3 when using a Nikon D70-Series digital camera, otherwise the flash will not fire.

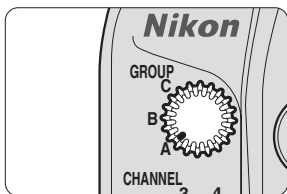

### 2 Rotate the [GROUP] select dial on the SB-R200 to set the group.

- Set the group of the SB-R200 to Group A when using a Nikon D70-Series camera, otherwise the flash unit will not fire.

## Flash operation using the R1

6

**Compose a picture and shoot with flash.**

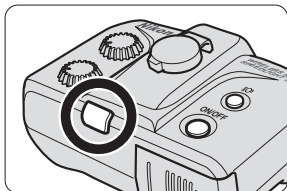

**1 Compose the picture and shoot.**

Ensure that the red ready-light on the SB-R200 is on, then release the shutter.

- For details on test firing, refer to page 88.

**☑ If the red ready-light blinks immediately after shooting**

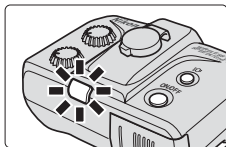

In TTL mode, when the SB-R200 flash has fired at its maximum output and underexposure may have occurred, the red ready-light on the SB-R200 will blink for approx. 3 sec. (The ready-light in the camera's viewfinder does not blink.)

To compensate, set a higher ISO sensitivity or use a wider aperture and reshoot.

# Functions and use of the SU-800

---

This section describes the functions and use of the SU-800.

- 
- 1** SU-800's available flash operations
  - 2** Using the SU-800
  - 3** Functions of the SU-800

# 1 SU-800's available flash operations

The SU-800 has the following flash operations. Refer to the corresponding pages for details on each flash operation.

Available flash operation	Usable cameras	Usable Speedlights
Close-up (p. 65)	CLS-compatible cameras Cameras not compatible with CLS*1	SB-R200
Commander (p. 79)	CLS-compatible cameras	SB-R200, SB-910*2, SB-900*2, SB-800*2, SB-700*2, SB-600*2

\*1 The optional TTL Cord SC-30 is required (p. 123).

**Note:** With CLS-compatible cameras, the TTL Cord SC-30 (optional) is not required.

\*2 Repeating flash operation is possible (p. 93).

## 2 Using the SU-800

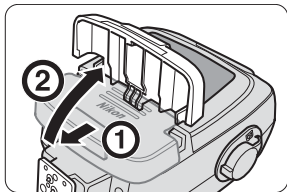

- 1** Slide open the battery chamber lid in the direction of the arrow.

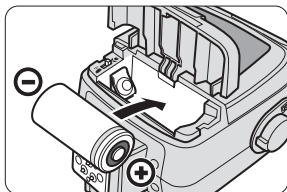

- 2** Install the battery, then close the battery chamber lid by sliding it into place.

Use CR123A (3V) lithium batteries.

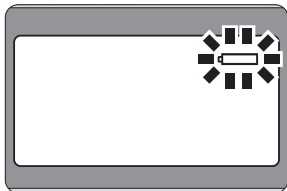

### Replacing the battery

The low battery-power indicator blinks when the SU-800's ready-light does not come on within about 30 seconds of the power being turned on or after the flash has fired.

- Replace the battery.

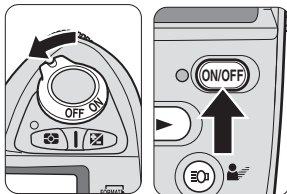

- 3** Turn off the camera and SU-800.

## 2 Using the SU-800

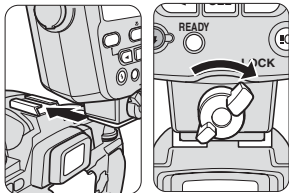

- 4** Rotate the Mounting Foot lock lever to the left, slide the SU-800's Mounting Foot into the camera's accessory shoe and turn the lock lever to the right.

### ☑ Mounting Foot lock lever



To lock the SU-800 in place, turn the lock lever clockwise approx. 90° until it stops. To unlock, turn the lever counterclockwise until it stops.

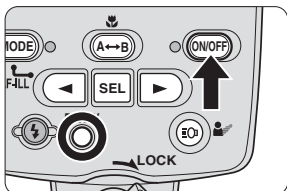

- 5** Press the [ON/OFF] buttons on the camera and SU-800 to turn on the power.

- Ensure that the ready-light on the SU-800 comes on.

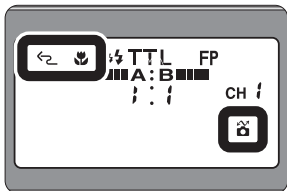

- 6** Confirm the SU-800's LCD panel.

Ensure that Wireless flash, Close-up mode and CLS-compatible camera indicators are correctly displayed.



## ● The SU-800's auto power-off function and camera's exposure meter-off function

---

With a camera body that is compatible with TTL auto flash, the SU-800 goes into standby mode when the camera's exposure meter turns off.

Without a camera body, if the SU-800 is not being used for approx. 40 seconds, the standby function activates and automatically turns the SU-800 off to conserve battery power.

- No indicators are displayed on the LCD panel in standby mode.
- When in standby mode or when the exposure meter is off, the SU-800 comes back on again when:

The [ON/OFF] button on the SU-800 is pressed.

The camera's power is turned on.

# 3 Functions of the SU-800

The following functions can be set on the SU-800.

## Switching functions between close-up and Commander functions

Use the Commander/Close-up select switch to toggle between close-up and Commander functions.

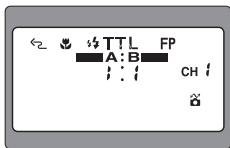
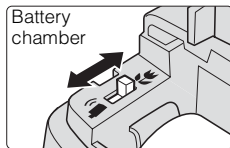

Display in close-up mode

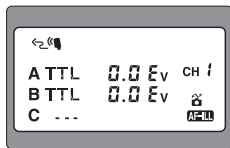

Display in Commander mode

## Settings in each flash mode

### In close-up mode (p. 65)

- Flash mode (TTL, M)
- Group name (A, B, C)
- Flash firing/canceling for group A or B
- Flash output-level ratio between groups A and B
- Flash output-level compensation value (in TTL mode)
- Manual flash output level (in M mode)
- Channel number (1, 2, 3, 4)

### In Commander mode (p. 79)

- Flash mode of remote flash unit(s) (TTL, Auto Aperture flash (AA), M, --- (flash canceled), RPT (Repeating) flash)
- Group name (A, B, C)
- Flash output-level compensation value (in TTL and Auto Aperture flash (AA) modes)
- Manual flash output level (in M mode)
- Manual flash output level, the frequency, and the number of repeating flashes per frame (in RPT mode)
- Channel number (1, 2, 3, 4)

# Functions and use of the SB-R200

---

This section describes the functions and use of the SB-R200.

- 
- 1** SB-R200's available flash operations
  - 2** Using the SB-R200
  - 3** Functions of the SB-R200

# 1 SB-R200's available flash operations

The following flash operations are available with the SB-R200. Refer to the corresponding pages for details on each flash operation.

Available flash operation	Usable cameras and Speedlights
Close-up (p. 65)	CLS-compatible cameras, cameras not compatible with CLS*1, SU-800
Commander (p. 79)	CLS-compatible cameras featuring Commander function, SU-800, SB-910, SB-900, SB-800, SB-700

\*1 The optional TTL Cord SC-30 is required (p. 123).

**Note:** With CLS-compatible cameras, the TTL Cord SC-30 (optional) is not required.

## **☑ Commander mode of SB-910, SB-900, SB-800 and SB-700**

In the Commander mode, although the SB-910, SB-900, SB-800 or SB-700 is set as the Master flash unit and its flash mode is set to Flash canceled (---), the flash will fire at a reduced flash output level. This may affect the correct exposure of the subject if the subject is close. To limit this effect as much as possible, bounce the light by tilting or rotating the flash head.

## 2 Using the SB-R200

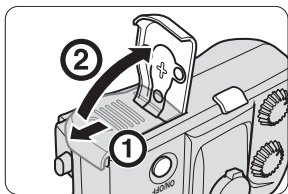

- 1** Slide open the battery chamber lid in the direction of the arrow.

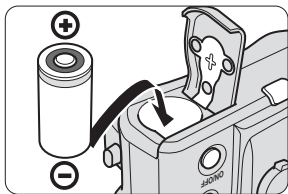

- 2** Install the battery, then close the battery chamber lid by sliding it into place.

Use CR123A (3V) lithium batteries.

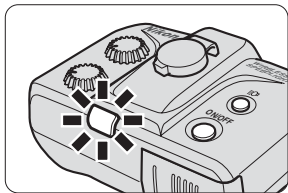

### Replacing the battery

When the SB-R200's battery power is weak, the green ready-light blinks after the power has been turned on or after the flash has fired

- Replace the battery.

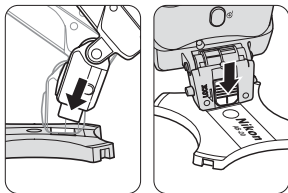

- 3** Slide the SB-R200's Mounting Foot into the Speedlight Stand AS-20's Speedlight Mounting Shoe and slide the lock switch.

The Mounting Foot cannot be inserted in reverse.

- Slide the lock switch until it stops and make sure that the red part can no longer be seen.

### Attaching the SB-R200 to the front of the lens

- The SB-R200 can be attached to the front of the lens using the Attachment Ring SX-1 (p. 31).

## 2 Using the SB-R200

### 4 Set up the SB-R200.

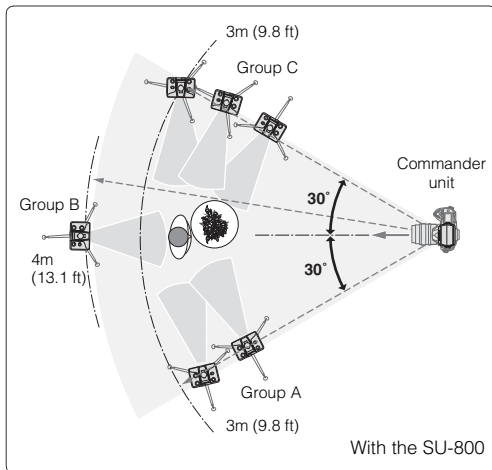

The setup range of the SB-R200 units varies depending on cameras featuring Commander function or Speedlight. For details, see your Speedlight or camera's user's manual.

- Be sure to place all SB-R200 units that are set in the same group close together.
- For notes on setting up the SB-R200, see "Setting up the SB-R200" on page 108.

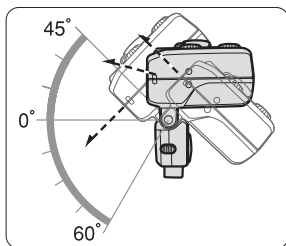

### 5 Adjust the SB-R200's flash head.

The flash head of the SB-R200 tilts down to 60° and up to 45°. The flash head can be set at click stops every 15°.

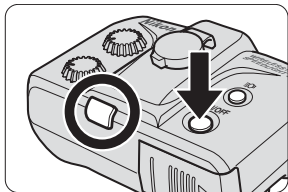

- 6** Press the [ON/OFF] button on the camera, or the SB-910, SB-900, SB-800, SU-800 and SB-R200 to turn on the power.

Ensure that the red ready-light on the camera, the SB-910, SB-900, SB-800, SU-800 or on the SB-R200 comes on.

## 3 Functions of the SB-R200

The following functions can be set on the SB-R200.

### ● **Switching the Target Light (focus assist lamp) on or off**

---

Use the Target Light button to illuminate or cancel the Target Light (p. 90).

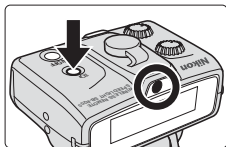

### ● **Items to be set**

---

- Group name (A, B, C)
- Channel number (1, 2, 3, 4)



# Details on close-up flash operation and shooting procedures

---

(Used with CLS-compatible cameras)

This section describes in detail **wireless close-up flash operation** and shooting procedures with CLS-compatible cameras. Also read “Close-up Speedlight Photography Examples,” a separate booklet that provides example photos. Be sure to read your camera user’s manual for specific information on camera settings and functions.

- 
- 1** Close-up flash operation
  - 2** Overview of close-up flash operation
  - 3** Procedures for close-up flash operation

# 1 Close-up flash operation

Wireless close-up flash operation is possible when the SU-800 and SB-R200 are used with CLS-compatible cameras. The SB-R200 can be attached to the front of the lens, held in your hand, or freely positioned by using the Speedlight Stand AS-20. The flexibility of close-up flash operation sets it apart from conventional lighting systems.

## Example A



### Dual-light close-up flash operation (one flash unit attached to the front of the lens + one held in the hand)

With one SB-R200 attached to the front of the lens, the subject in front is strongly illuminated, while a second SB-R200 held in the hand illuminates the subject from the left to soften harsh shadows and further highlight the subject, in this case a ladybug.

## Example B

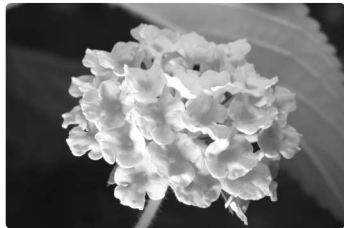

### Dual-light close-up flash operation (one flash unit attached to the front of the lens + one held in the hand)

With one SB-R200, held in the hand, used as the main flash unit, the subject is strongly illuminated from the lower left, while a second SB-R200 attached to the front of the lens is used to illuminate the subject from the upper right to emphasize the contours of the flower's petals, resulting in softened textures.

## A-1

### Flash setup

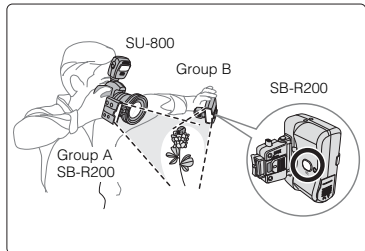

- Camera: D70
- Lens: AF Micro-Nikkor 105mm f/2.8D
- Group A: SB-R200 (TTL)
- Group B: SB-R200 (TTL)

A-2, A-3, and A-4 examples in "Close-up Speedlight Photography Examples" were also taken under the same conditions as with A-1.

## B-1

### Flash setup

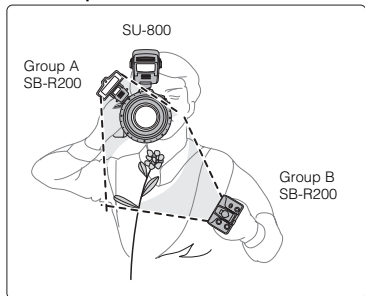

- Camera: D70
- Lens: AF Micro-Nikkor 60mm f/2.8D
- Group A: SB-R200 (TTL)
- Group B: SB-R200 (TTL)

B-2, B-3, and B-4 examples in "Close-up Speedlight Photography Examples" were also taken under the same conditions as with B-1.

## Example E

E-3



- Camera: D70
- Lens: AF-S DX Zoom-Nikkor 18-70mm f/3.5-4.5G IF-ED
- Group A: SB-R200 (TTL)

### Dual-light close-up flash operation (one flash unit attached to the front of the lens + one remote unit bounced off the wall)

This picture was taken as an example of how to show cloth texture detail and pattern in such products as children's wear and handicrafts for the purpose of displaying on Internet auction sites. Light and shadows cast due to the difference in flash output levels between flash units on the right and on the left create more natural looking pictures, enabling the real textures of the material to be revealed.

- Group B: SB-R200 (TTL)
- E-4 example in "Close-up Speedlight Photography Examples" was taken under the same conditions as with E-3.

## Example F

F-4



F-5



### Single-light close-up flash operation

Comparison of lighting effects due to differences in shooting distances. The subject (F-4) is approx. 10 cm (3.9 in.) away from the camera, while subject (F-5) is 70 cm (2.3 ft) from the camera. The shorter the distance between the subject and camera, the greater the lighting effects, and the longer the distance, the less there are shadows.

- Camera: D70
- Lens (F-4): AF Micro-Nikkor 60mm f/2.8D
- Lens (F-5): AF Micro-Nikkor 200mm f/4D IF-ED
- Group A: SB-R200 (TTL)

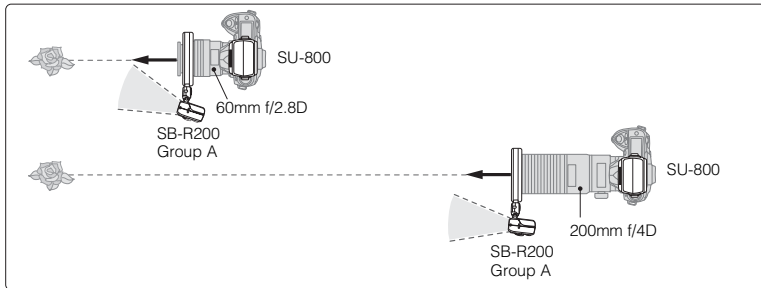

## 2 Overview of close-up flash operation

### What is close-up flash operation

The SU-800 can perform close-up flash operation to wirelessly control the SB-R200 flash operation when mounted on CLS-compatible cameras.

Two types of close-up flash operations are available: (1) Dual-light close-up flash operation (the SB-R200 units are divided into two groups (A, B)), and (2) triple-light close-up flash operation (the SB-R200 units are divided into three groups (A, B, C)).

### Switching between “dual-light close-up flash operation” and “triple-light close-up flash operation”.

Press and hold the [SEL](FUNC.) button for approx. 2 seconds to toggle between “dual-light” and “triple-light” close-up flash operations.

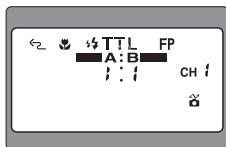

Display in dual-light close-up flash operation.

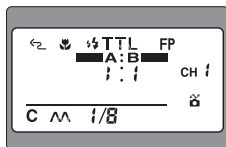

Display in triple-light close-up flash operation.

### Methods for setting up

Set up the SU-800 and SB-R200 in the same way as “Flash operation using the Nikon Close-up Speedlight Commander Kit R1C1” (p. 28).

### Items to be set

The following items can be set in the close-up flash operation.

- Flash mode (TTL, M)
- Group name (A, B, C)
- Flash firing/canceling for groups A and B
- Flash output level ratio between groups A and B (in TTL mode)
- Flash output level compensation (in TTL mode)
- Manual flash output level (in M mode)
- Channel number (1, 2, 3, 4)

## Flash modes

In the close-up flash operation, the TTL and M (manual) flash modes are available. Every time you press the [MODE] button on the SU-800, the available flash mode changes.

- The available flash modes vary, depending on cameras and lenses in use.
- The same flash mode is set for both Groups A and B.
- In triple-light close-up flash operation, the TTL and M (manual) flash modes are available for Groups A and B. For Group C, only the M (manual) flash mode is available.

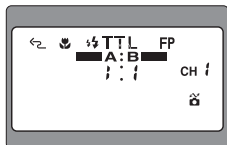

Display in dual-light close-up flash operation (in TTL mode)

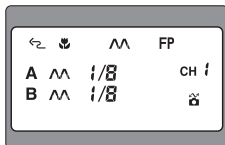

Display in dual-light close-up flash operation (in M (manual) mode)

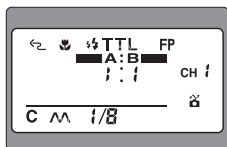

Display in triple-light close-up flash operation (in TTL mode)

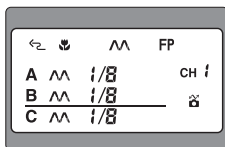

Display in triple-light close-up flash operation (in M (manual) mode)

# 3 Procedures for close-up flash operation

## Procedures for dual-light close-up flash operation

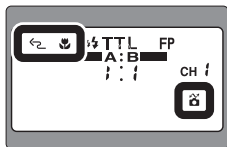

**1** Press the [ON/OFF] buttons to turn on the camera, SU-800 and SB-R200.

- Ensure that the red ready-lights on the SU-800 and SB-R200 are on.
- Confirm that Wireless flash, close-up mode and CLS-compatible camera indicators are correctly displayed on the SU-800

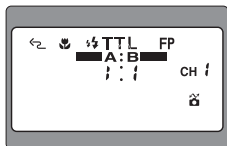

**2** Selecting dual-light flash operation.

Press and hold the [SEL](FUNC.) button for approx. 2 seconds to toggle between "dual-light" and "triple-light" close-up flash operations.

- "Dual-light" is preset when shipped from the factory.

Display in dual-light close-up flash operation

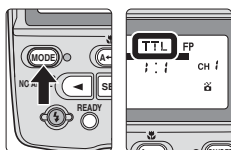

**3** Setting the flash mode on the SU-800.

Press the [MODE] button to set the flash mode to TTL or M (manual).

- "TTL" is preset when shipped from the factory.
- The same flash mode is set for both Groups A and B.

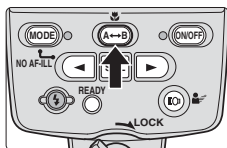

**4** Setting the SB-R200 to fire or cancel.

Press the [A↔B] select button to set flash firing/canceled for group A or B.

- The flash-canceled group name disappears.
- In dual-light close-up flash operation, you cannot cancel flash firing for Groups A and B.
- Once set to flash canceled mode, flash output-level ratio in TTL mode becomes invalid, while the flash output level compensation values are retained.
- Even if the flash mode is set to flash canceled, flash output level compensation values in the M (manual) mode are retained.

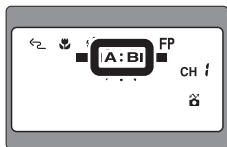

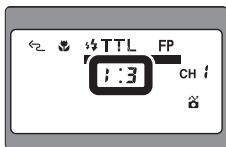

## 5 Setting the SB-R200's flash output level ratio between groups A and B (in TTL mode).

Press the [SEL](FUNC.) button to display flash output level ratio (blinking), then press the [◀] or [▶] button to increase or decrease the ratio. Press the [SEL](FUNC.) button once again and the flash output level ratio stops blinking. The last value to blink is the one that has been set automatically.

- The flash output level ratio can be set from 8:1 to 1:8.
- As the ratio changes, the flash output level indicator bar varies.
- Continuously pressing the [◀] or [▶] button quickly increases or decreases the ratio.
- The flash output level ratio blinks during adjustment and stops after blinking six times unless an adjustment is made. The last value to blink is the one that has been set automatically.

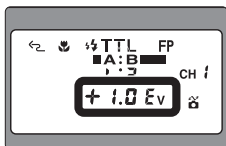

## 6 Setting the SB-R200's flash output level compensation value (in TTL mode).

Press the [SEL](FUNC.) button to display the flash output level compensation value (blinking). Press the [◀] or [▶] button to increase or decrease the compensation value. Press the [SEL](FUNC.) button once again and the flash output level stops blinking. The last value to blink is the one that has been set automatically.

- The same flash output level compensation value is set for both Groups A and B.
- The flash output level compensation values can be set in 1/3 step increments or decrements from +3.0 to -3.0 EV.
- The values are displayed in decimal format, like 0.3 for 1/3, and 0.7 for 2/3.
- Continuously pressing the [◀] or [▶] button quickly increases or decreases the value.
- The flash output level blinks during adjustment and stops after blinking six times unless an adjustment is made. The last value to blink is the one that has been set automatically.

### 3 Procedures for close-up flash operation

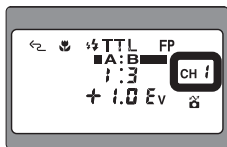

#### 7 Setting a channel number on the SU-800.

Set the communication channel numbers of the SU-800 and SB-R200. Press the [SEL](FUNC.) button to display the channel number. Press the [◀] or [▶] button to set the channel number (blinking). Press the [SEL](FUNC.) button once again and the channel number stops blinking. The last channel number to blink is the one that has been set automatically.

- Select one of the four available channels. The same channel number is set for all groups.
- The channel number blinks during adjustment and stops after blinking six times unless an adjustment is made. The last channel number to blink is the one that has been set automatically.

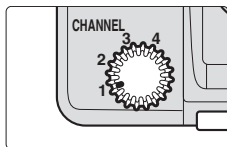

#### 8 Setting a channel number on the SB-R200.

Rotate the [CHANNEL] select dial on the SB-R200 to set the channel number. Be sure to set the same channel number as set on the SU-800.

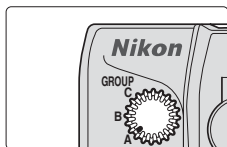

#### 9 Setting a group on the SB-R200.

Rotate the [GROUP] select dial on the SB-R200 to set the group. Once set, the SB-R200 operates according to the controls as set on the SU-800.

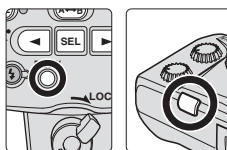

#### 10 Compose a picture and shoot with flash.

Confirm that the red ready-lights on the SU-800 and SB-R200 are on, then release the shutter.

- For details on test firing, refer to page 88.



## ✔ If the red ready-light blinks immediately after shooting

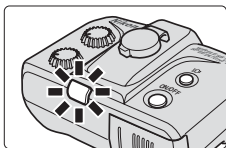

In the TTL mode, when the SB-R200 flash has fired at its maximum output and underexposure may have occurred, the red ready-light on the SB-R200 blinks for approx. 3 sec. (The ready-lights on the SU-800 and in the camera's viewfinder do not blink.)

To compensate, set a higher ISO sensitivity or use a wider aperture and reshoot.

## ☑ In the M (manual) mode, set the manual flash output level for Groups A and B.

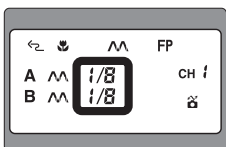

Press the [SEL](FUNC.) button to display the manual flash output level (blinking). Press the [◀] or [▶] button to increase or decrease the value. Press the [SEL](FUNC.) button once again and the manual flash output level stops blinking. The last value to blink is the one that has been set automatically.

- Manual flash output level can be set separately for each group.
- Manual flash output level can be set in 1 step increment or decrement from M1/1 to M1/64 output level (M1/8 is preset when shipped from the factory).
- Pressing the [◀] or [▶] button continuously increases or decreases the value quickly.
- Manual flash output level blinks during adjustment and stops after blinking six times unless an adjustment is made. The last value to blink is the one that has been set automatically.

## 3 Procedures for close-up flash operation

### Procedures for triple-light close-up flash operation

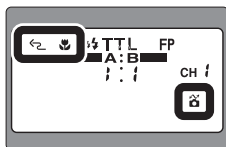

**1** Press the [ON/OFF] buttons to turn on the camera, the SU-800 and SB-R200.

- Ensure that the red ready-lights on the SU-800 and SB-R200 are on.
- Confirm that Wireless flash, Close-up mode and CLS-compatible camera indicators are correctly displayed on the SU-800.

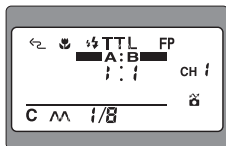

**2** Selecting triple-light flash operation.

Press and hold the [SEL](FUNC.) button for approx. 2 seconds to toggle between "dual-light" and "triple-light" close-up flash operations.

- "Dual-light" is preset when shipped from the factory.

Display in triple-light close-up flash operation

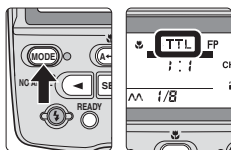

**3** Setting the flash mode on the SU-800.

Press the [MODE] button to set the flash mode to TTL or M (manual).

- "TTL" is preset when shipped from the factory.
- The same flash mode is set for both Groups A and B.
- Only the M (manual) flash mode is available for Group C.

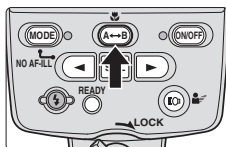

**4** Setting the SB-R200 to fire or cancel.

Press the [A<->B] select button to set flash firing/canceled for Group A or B.

- The flash-canceled group name disappears.
- You can cancel flash firing for Groups A and B, but not for Group C.
- Once set to flash canceled mode, flash output-level ratio in TTL mode becomes invalid, while the flash output level compensation values are retained.
- Even if the flash mode is set to flash canceled, flash output level compensation values in the M (manual) mode are retained.

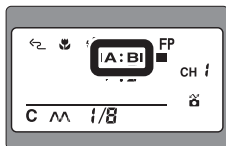

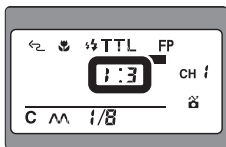

- 5** Setting the SB-R200's flash output level ratio between Groups A and B (in TTL mode). Press the [SEL](FUNC.) button to display flash output level ratio (blinking), then press the [◀] or [▶] button to increase or decrease the ratio. Press the [SEL](FUNC.) button once again and the flash output level ratio stops blinking. The last value to blink is the one that has been set automatically.
- The flash output level ratio can be set from 8:1 to 1:8.
  - As the ratio changes, the flash output level indicator bar varies.
  - Continuously pressing the [◀] or [▶] button quickly increases or decreases the ratio.
  - The flash output level ratio blinks during adjustment and stops after blinking six times unless an adjustment is made. The last value to blink is the one that has been set automatically.

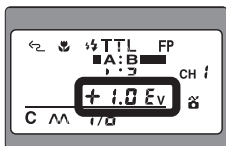

- 6** Setting the SB-R200's flash output level compensation value (in TTL mode). Press the [SEL](FUNC.) button to display the flash output level compensation value (blinking). Press the [◀] or [▶] button to increase or decrease the compensation value. Press the [SEL](FUNC.) button once again and the flash output level stops blinking. The last value to blink is the one that has been set automatically.
- The same flash output level compensation value is set for both Groups A and B.
  - The flash output level compensation values can be set in 1/3 step increments or decrements from +3.0 to -3.0 EV.
  - The values are displayed in decimal format, like 0.3 for 1/3, and 0.7 for 2/3.
  - Continuously pressing the [◀] or [▶] button quickly increases or decreases the value.
  - The flash output level blinks during adjustment and stops after blinking six times unless an adjustment is made. The last value to blink is the one that has been set automatically.

### 3 Procedures for close-up flash operation

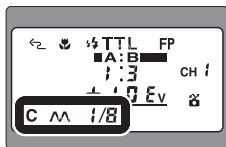

- 7** Setting the manual flash output level for group C. Press the [SEL](FUNC.) button to display manual flash output level (blinking) for group C, then press the [◀] or [▶] button to increase or decrease the value. Press the [SEL](FUNC.) button once again and the flash output level stops blinking. The last value to blink is the one that has been set automatically.

- Manual flash output level can be set separately for each group.
- The flash output level can be set from M1/1 to M1/64. (M1/8 is preset when shipped from the factory.)
- Press and hold the [◀] or [▶] button to quickly increase or decrease the value.
- The flash output level ratio blinks during adjustment and stops after blinking six times unless an adjustment is made. The last value to blink is the one that has been set automatically.

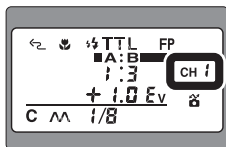

- 8** Setting a channel number on the SU-800.

Set the communication channel numbers of the SU-800 and SB-R200. Press the [SEL](FUNC.) button to display the channel number (blinking). Press the [◀] or [▶] button to set the channel number. Press the [SEL](FUNC.) button once again and the channel number stops blinking. The last channel number to blink is the one that has been set automatically.

- Select one of the four available channels. The same channel number is set for all groups.
- The channel number blinks during adjustment and stops after blinking six times unless an adjustment is made. The last channel number to blink is the one that has been set automatically.

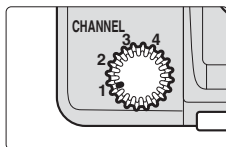

- 9** Setting a channel number on the SB-R200.

Rotate the [CHANNEL] select dial on the SB-R200 to set the channel number. Be sure to set the same channel number as set on the SU-800.

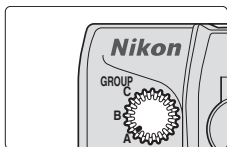

- 10** Setting a group on the SB-R200.  
Rotate the [GROUP] select dial on the SB-R200 to set the group. Once set, the SB-R200 operates according to the controls as set on the SU-800.

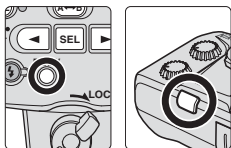

- 11** Compose a picture and shoot with flash.  
Confirm that the red ready-lights on the SU-800 and SB-R200 are on, then release the shutter.
- For details on test firing, refer to page 88.

### ☑ If the red ready-light blinks immediately after shooting

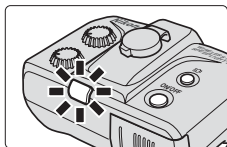

In the TTL mode, when the SB-R200 flash has fired at its maximum output and underexposure may have occurred, the red ready-light on the SB-R200 blinks for approx. 3 sec. (The ready-lights on the SU-800 and in the camera's viewfinder do not blink.)

To compensate, set a higher ISO sensitivity or use a wider aperture and reshoot.



# Details on Commander flash operation and shooting procedures

---

(Used with CLS-compatible cameras)

This section describes the details of available **wireless Commander flash operation** and necessary procedures with CLS-compatible cameras.

Also read “Close-up Speedlight Photography Examples,” a separate booklet that contains example photos.

Be sure to refer to your camera user’s manual for specific information on camera settings and functions.

- 
- 1** Commander flash operation
  - 2** Overview of Commander flash operation
  - 3** Procedures for Commander flash operation

# 1 Commander flash operation

The Commander function enables the SU-800 to act as a Commander unit to trigger remote flash units without firing itself. By rearranging the remote flash setups, you can enjoy rendering a variety of lighting effects.

## Example D



### Triple-light flash operation

Three flash units positioned at different locations are used in order to represent the color and textures of the overall table setting. The SB-800 is used as a main flash unit to provide strong illumination on the table from the upper left. SB-R200 units on both the right and left sides eliminate the shadows. In this way, a much more vivid rendition of food and dishes on the periphery of the table is created.

D-1

### Flash setup

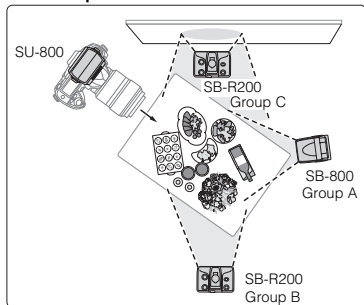

- Camera: D70
- Lens: AF-S DX Zoom-Nikkor 18-70mm f/3.5-4.5G IF-ED
- Group A: SB-800 (TTL)
- Group B: SB-R200 (TTL)
- Group C: SB-R200 (M)

D-2 example in "Close-up Speedlight Photography Examples" was taken using a single built-in flash.

## Example D



### Triple-light flash operation

Two SB-R200 units on the right and left are used directly from the top to clearly represent the color and contours of dishes on a plate. In addition, another SB-R200 is used from the rear left with reduced flash output to render a steaming dish of hot food against a dark background.

D-3

### Flash setup

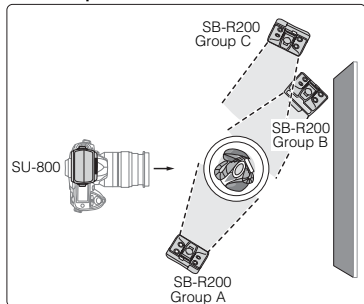

- Camera: D70
- Lens: AF Micro-Nikkor 105mm f/2.8D
- Group A: SB-R200 (TTL)
- Group B: SB-R200 (TTL)
- Group C: SB-R200 (M)



## Example F

F-1



### Single-light flash operation (off-camera flash)

With a single off-camera flash unit used behind the subject, distinct, intentional shadows appear, emphasizing the subject's sturdiness. Usually, with an on-camera flash, a sense of flatness is unavoidable. However, in this situation, the position of the SB-R200 can be rearranged with ease, providing a variety of lighting and shadow effects.

### Flash setup

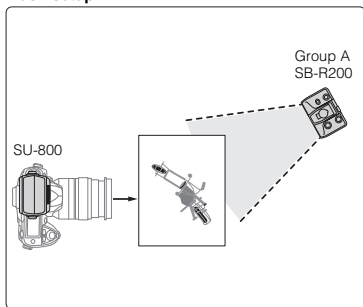

- Camera: D70
- Lens: AF-S DX Zoom-Nikkor 18-70mm f/3.5-4.5G IF-ED
- Group A: SB-R200 (TTL)

F-2 example in "Close-up Speedlight Photography Examples" was taken under the same conditions as with F-1. F-3 was taken using a single built-in flash.

## Example G

G-1



### Triple-light flash operation

To create a more natural looking picture of flowers in terms of colors and textures, one SB-R200 from the top is used as a main flash unit in addition to lighting setups from the front and rear. Two SB-R200 attached to the front of the lens eliminate harsh shadows. Another SB-R200 bounced from the rear emphasizes the subject contours and brightens the backgrounds.

### Flash setup

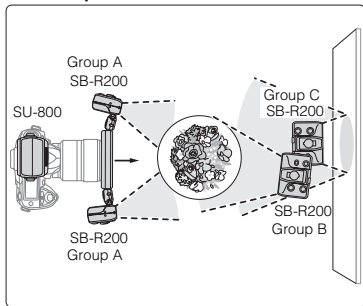

- Camera: D70
- Lens: AF Micro-Nikkor 105mm f/2.8D
- Group A: SB-R200 (TTL)
- Group B: SB-R200 (TTL)
- Group C: SB-R200 (M)

G-2 example in "Close-up Speedlight Photography Examples" was taken using flash units in Groups A and B. G-3 was taken using flash units in Group A only.

# 2 Overview of Commander flash operation

## Example J



### Dual-light flash operation

Ring-type lighting is used with a total of eight SB-R200 units attached to the Attachment Ring SX-1. Another SB-R200 is placed behind to bounce the light off the background wall to create a magical atmosphere.

## J-1

### Flash setup

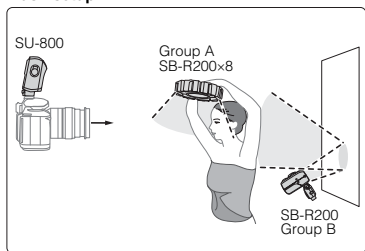

- Camera: D70
- Lens: AF-S DX Zoom-Nikkor 18-70mm f/3.5-4.5G IF-ED
- Group A: SB-R200 (TTL) x8
- Group B: SB-R200 (TTL)

J-3 and J-4 examples in "Close-up Speedlight Photography Examples" was taken under the same conditions as with J-1. J-2 was taken using a single flash unit.

## Commander and remote flash units

Commander flash operation is possible when CLS-compatible cameras are used with the following Commander and remote flash units. The Commander flash unit provides wireless control of the flash operation of 3-grouped (A, B, C) remote flash units.

### Flash units usable as a Commander unit

- Wireless Speedlight Commander SU-800
- CLS-compatible cameras with Commander function
- Speedlight SB-910, SB-900, SB-800

### Flash units usable as a remote flash unit

- Wireless Remote Speedlight SB-R200
- Speedlight SB-910, SB-900, SB-800, SB-700, SB-600

## ☑ SB-910, SB-900 or SB-800 Commander mode

In the Commander mode, although the SB-910, SB-900 or SB-800 is set as the Master flash unit and its flash mode is set to Flash Canceled (---), the flash will fire at a reduced flash output level. This may affect the correct exposure of the subject if the subject is close. To limit this effect as much as possible, bounce the light by tilting or rotating the SB-910, SB-900 or SB-800 flash head.

## Notes on performing Commander flash operation

Available Commander functions and necessary settings vary depending on the cameras and remote flash units in use. Be sure to refer to your Speedlight user's manual.

## ● Methods for setting up

Set up the Commander and remote flash units in the same way as in “Flash operation using the Nikon Close-up Speedlight Commander Kit R1C1” (p. 38).

## ● Items to be set

The following items can be set in Commander flash operation.

- Flash mode of remote flash units (TTL, Auto Aperture flash (AA), M, --- (flash canceled), RPT (repeating) flash)
- Group name (A, B, C)
- Flash output level compensation (in TTL and Auto Aperture flash (AA) modes)
- Manual flash output level (in M mode)
- Manual flash output level, the frequency, the number of repeating flashes per frame (in RPT mode)
- Channel number (1, 2, 3, or 4)

## ● Flash modes

In Commander flash operation, the five flash modes (TTL, Auto Aperture flash (AA), M, --- (flash canceled), RPT (repeating)) are available.

- Flash modes can be separately set for each group (except RPT).
- Available flash modes vary depending on the camera and remote flash units in use.

### Available flash modes with the SU-800 for remote flash units

Flash mode	SB-R200	SB-910/SB-900/SB-800	SB-700/SB-600
TTL	○	○	○
Auto Aperture flash (AA)*1	X	○	X
M	○	○	○
--- (canceled)	○	○	○

\*1 Auto Aperture flash mode is possible only when the SB-910, SB-900 or SB-800 is used as a remote flash unit in combination with CPU lenses. (A warning indicator appears when the SB-R200, SB-700 or SB-600 is used in the Auto Aperture flash mode.)

### ☑ Repeating flash operation

Repeating (RPT) flash operation is possible when the SU-800 is used with the SB-910, SB-900, SB-800, SB-700 or SB-600 (p. 93).

### ☑ Lenses

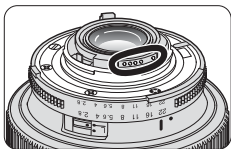

In this manual, NIKKOR lenses are divided into two types: CPU NIKKOR lenses and non-CPU NIKKOR lenses. CPU lenses have CPU contacts.

# 3 Procedures for Commander flash operation



## 1 Press the [ON/OFF] buttons to turn on the camera, the Commander and remote flash units.

- Ensure that the red ready-lights come on and the flash units have been fully recycled.
- Ensure that Wireless flash, Commander mode and CLS-compatible camera indicators are all displayed on the LCD panel.

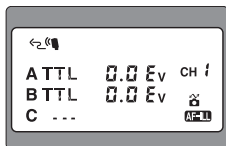

## 2 Setting the Commander functions

Set the Commander's Commander functions.

- Press and hold the [SEL](FUNC.) button for approx. 2 seconds to toggle between the Commander mode and Repeating (RPT) mode.

Display in Commander mode

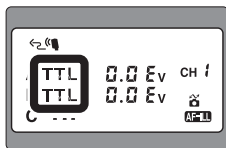

## 3 Setting the flash mode of the remote flash units

Set the remote flash unit's flash mode to TTL, Auto Aperture flash (AA), M, or --- (flash canceled).

- Press the [SEL](FUNC.) button to display the flash mode (blinking) for each group. Press the [MODE] button to set the flash mode.

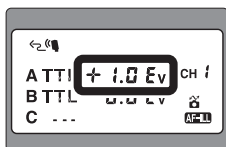

## 4 Setting the flash output level compensation of the remote flash units (in TTL or Auto Aperture flash (AA) mode)

The flash output level compensation values can be set in 1/3 step increments or decrements from +3.0 to -3.0 EV.

- Flash output level compensation values can be set separately for each group.
- Press the [SEL](FUNC.) button to display the flash output level compensation value (blinking) for the group. Press the [◀] or [▶] button to increase or decrease the value. Press the [SEL](FUNC.) button again and the value will stop blinking. The last value to blink is the one that has been set automatically.
- The values are displayed in decimal format, like 0.3 for 1/3, and 0.7 for 2/3.
- Continuously pressing the [◀] or [▶] button quickly increases or decreases the value.
- The value blinks during adjustment and stops after blinking six times unless an adjustment is made. The last value to blink is the one that has been set automatically.



## 5 Setting a channel number on the Commander unit.

Set the communication channel through which the Commander and remote flash units exchange data.

- Select one of the four available channels. The same channel number is set to all groups A, B and C.
- Press the [SEL](FUNC.) button to display the channel number (blinking). Press the [◀] or [▶] button to change the channel number. Press the [SEL](FUNC.) button once again and the channel number will stop blinking. The last channel number to blink is the one that has been set automatically.
- The channel number blinks during adjustment and stops after blinking six times unless an adjustment is made. The last channel number to blink is the one that has been automatically set.

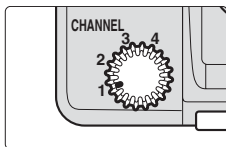

## 6 Setting a channel number on the remote flash unit(s)

Select one of the four available channels. Be sure to set the same channel number as set on the SU-800.

- Be sure to set the channel number of the remote flash unit(s) to 3 when using a Nikon D70-Series camera, otherwise the remote flash unit(s) will not fire.
- With the SB-R200, rotate the [CHANNEL] select dial to set the channel number.
- With the SB-910, SB-900, SB-800, SB-700 or SB-600, read the user's manual for each model.

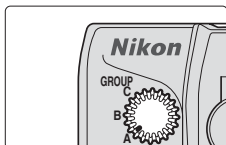

## 7 Setting a group on the remote flash unit(s)

Set the group of remote flash unit(s) to A, B or C. Once set, the remote flash units will operate according to the controls for each group as set on the Commander.

- Set the group of the remote unit(s) to group A or B when using a Nikon D800-Series, D700, D300-Series, D200, D90, D80 or D7000 camera, otherwise the flash unit(s) will not fire.
- Set the group of the remote unit(s) to group A when using a Nikon D70-Series camera, otherwise the flash unit(s) will not fire.
- With the SB-R200, rotate the [GROUP] select dial to set the group name.
- With the SB-910, SB-900, SB-800, SB-700 or SB-600, read the user's manual for each model.

### 3 Procedures for Commander flash operation

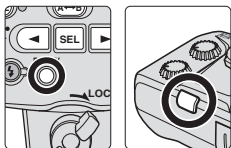

- 8** Compose a picture and shoot with flash  
Confirm that the red ready-lights are on then release the shutter.
- For details on test firing, refer to page 88.

#### **✔ If the red ready-light blinks immediately after shooting**

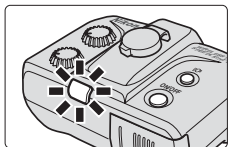

In TTL mode, when the flash has fired at its maximum output and underexposure may have occurred, the red ready-light on that flash unit will blink for approx. 3 sec. (The ready-lights on the SU-800 and in the camera's viewfinder do not blink.) To compensate, move closer to the subject, set a higher ISO sensitivity or use a wider aperture and reshoot.

- When Speedlight SB-910, SB-900, SB-800, SB-700 or SB-600 is used as a remote flash unit, the red ready-light on the Speedlight in use blinks for 3 sec. after firing. The amount of underexposure is displayed. (For more details, read your Speedlight user's manual.)

#### **🔍 In the M (manual) mode, set manual flash output level.**

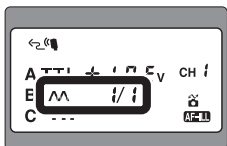

- Manual flash output level can be set separately for each group.
- Press the [SEL](FUNC.) button to display the manual flash output level (blinking). Press the [◀] or [▶] button to increase or decrease the value. Press the [SEL](FUNC.) button once again and the value will stop blinking. The last value to blink is the one that has been set automatically.
- Manual flash output level can be set in 1 step increment or decrement from M1/1 to M1/128 output. (M1/1 is preset when shipped from the factory.)
- Continuously pressing the [◀] or [▶] button quickly increases or decreases the value.
- The value blinks during adjustment and stops after blinking six times unless an adjustment is made. The last value to blink is the one that has been set automatically.

# Other functions

---

This section gives detailed information on each function of the SU-800 and SB-R200.

Be sure to refer to your camera user's manual for specific information on camera settings and functions.

- 
- 1** Test firing to confirm exposure
  - 2** Checking illumination before taking pictures (Modeling Illumination)
    - 3** Using the Target Light (Focus-Assist Illuminator)
    - 4** Autofocus flash operation in low light
    - 5** Flash output level compensation
    - 6** Repeating (RPT) flash operation
      - 7** Auto FP High-Speed Sync
      - 8** Flash Value Lock (FV Lock)

# 1 Test firing to confirm exposure

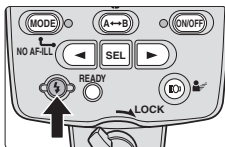

## In dual-light close-up flash operation

When the [Test] button on the SU-800 is pressed, the SB-R200 in Group A fires in one second, followed by the flash unit in Group B in two seconds at an M1/64 flash output level.

- Flash unit(s) in Group A or B of which flash firing is set to “canceled” also fire.

## In triple-light close-up flash operation

When the [Test] button on the SU-800 is pressed, the SB-R200 in Group A fires in one second, followed by the flash unit in Group B in two seconds, and the flash unit in Group C in 3 seconds at an M1/64 flash output level.

- Flash units in Group A, B or C of which flash firing has been set to “canceled” also fire.

## In Commander flash operation

When the [Test] button on the SU-800 is pressed, the remote flash unit(s) in Group A fires in one second, followed by the flash unit(s) in Group B in two seconds, and the flash unit(s) in Group C in 3 seconds.

- The flash output level varies during test firing depending on settings and flash mode.
- Flash units in Group A, B or C of which flash firing has been set to “canceled” also fire.

## In repeating (RPT) flash operation

When the [Test] button on the SU-800 is pressed, the remote flash unit(s) in Group A fires in one second, followed by the flash unit(s) in Group B in two seconds, and the flash unit(s) in Group C in 3 seconds.

- The flash output level varies during test firing depending on settings and flash mode.
- Flash units in groups A, B and C of which flash firing has been set to “canceled” also fire.



## 2 Checking illumination before taking pictures (Modeling Illumination)

Press the Target Light button and the flash fires repeatedly at a reduced flash output level. This is useful for checking illumination and shadows cast on the subject before actually taking the picture.

- This function operates only after the red ready-light comes on.

### In the close-up mode

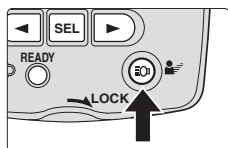

When the Target Light button on the SU-800 is pressed and released within 1 second, the Modeling Illuminator of the SB-R200 fires at a reduced flash output level for approx. 1 second.

When the preview button on a camera compatible with modeling illumination is pressed, the Modeling Illuminator of the SB-R200 also fires for approx. one second.

- If the Target light is on, the Target light goes off.
- The SB-R200 in a group of which flash firing is set to "canceled" does not fire.

### In the Commander mode

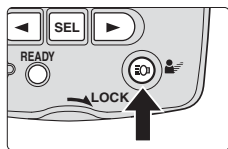

#### Firing by the SU-800

When the Target Light button on the SU-800 is pressed and released within 1 second, the Modeling Illuminators of remote flash units in the groups set to fire, indicated by the icon that is blinking, will fire for approx. one second.

- Remote flash unit(s) in a group of which flash firing is set to "canceled" does not fire.

#### Firing by the camera

When the preview button on a camera compatible with Modeling Illumination is pressed, the Modeling Illuminator of the remote flash unit fires for approx. 1 second.

- Remote flash unit(s) in a group of which flash firing is set to "canceled" does not fire.

### Do not release the shutter while the Modeling Illuminator is firing

If you release the shutter while the Modeling Illuminator is firing, correct exposure cannot be achieved.

## 3 Using the Target Light (Focus-assist Illuminator)

By using the Target Light on the SB-R200, you can confirm the direction of flash light emitted.

### ● Illuminating and canceling the Target Light using the Target Light button on the SU-800

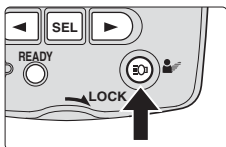

Press and hold the Target Light button on the SU-800 for more than 1 second, all Target Lights on the SB-R200 units light up.

- The Target Light illuminates for 60 seconds and goes out automatically. To cancel the illumination within 60 seconds, press the Target Light button again for more than one second.
- Pressing the button twice may be necessary depending on the conditions of the SB-R200.
- The Target Light also goes out when:
  - Releasing the shutter
  - Test firing
  - Firing the Modeling Illuminator
  - Pressing the [ON/OFF] button on the SB-R200
  - Pressing the Target Light button on the SB-R200
  - Turning on the camera's FV Lock

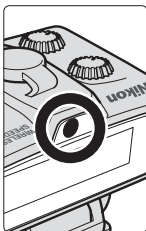

### ● Illuminating and canceling the Target Light using the Target Light button on the SB-R200

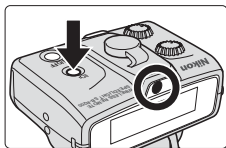

When the Target Light button on the SB-R200 is pressed while the SB-R200's Target Light is off, the Target Light comes on.

- If the Target Light is on, the Target light goes out.
- The Target Light illuminates for 60 seconds and goes out automatically. To cancel the illumination within 60 seconds, press the Target Light button again.

## 4 Autofocus flash operation in low light

In Commander and Repeating flash operations, if light is too low for normal autofocus operation, the SU-800's AF-Assist Illuminator comes on, enabling you to perform autofocus flash photography. This is activated by a signal from the camera.

- The AF-Assist Illuminator does not work in close-up flash operation.
- The SU-800's AF-Assist Illuminator supports CLS-compatible cameras' Multi-Area Autofocus system.

### The effective shooting distance with the AF-Assist Illuminator:

Approx. 1m to 10m (3.3 to 33 ft) with a 50mm f/1.8 lens or less, depending on the lens in use.

### Usable lens focal length:

24mm to 105mm

## Activating and canceling the AF-Assist Illuminator

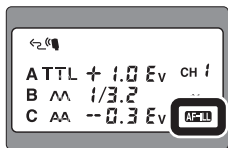

You can set the AF-Assist Illuminator to activate or cancel even when receiving a signal from the camera. Press the [MODE] + [◀] buttons simultaneously for approx. 2 seconds to toggle between the AF-ILL (activated) and the NO AF-ILL (canceled).

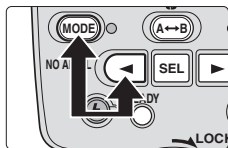

## Notes on using the AF-Assist Illuminator

- If the focus indicator does not appear in the camera's viewfinder even through the AF-Assist Illuminator is on, focus manually.
- The AF-Assist Illuminator will not light up if the camera's autofocus is locked or the SU-800's ready-light does not come on.
- Refer to your camera user's manual for more information.

## 5 Flash output level compensation

You can make exposure compensation for the flash illuminated subject without affecting the background exposure by modifying the flash unit's flash output level.

### **Setting the flash output level compensation**

---

As a basic guide, some plus compensation may be necessary to make the main subject brighter. Likewise, some minus compensation may be required to make the main subject darker.

### **In TTL auto and Auto Aperture flash operations (with the SB-910, SB-900 or SB-800)**

---

Making exposure compensation for a flash illuminated main subject by adjusting the SB-910's, SB-900's, SB-800's or Commander SU-800's flash output level compensation value.

- Compensation values can be set in 1/3 step increments or decrements from +3.0 to -3.0 EV.
- Flash output level compensation cannot be canceled by turning the flash unit off. To cancel, return the compensation value to "0".
- With SLR cameras featuring a built-in flash with an exposure compensation function, you can compensate the flash output level on either the camera or the SB-910, SB-900, SB-800 or SU-800 flash unit. (For details, see your camera's user's manual.) If you use both controls, the exposure is modified by the sum total of both compensation values.
- In this case, the LCD panel of the flash unit (SB-910, SB-900, SB-800 or SU-800) shows only the compensation value set on the flash unit (SB-910, SB-900, SB-800 or SU-800).

### **In Manual flash mode**

---

Making exposure compensation for only the flash illuminated subject by intentionally modifying the flash unit's flash output level.

### **Notes on performing Auto Aperture flash operation with the SB-910, SB-900 or SB-800.**

---

Depending on shooting circumstances, underexposure may occur. Using the TTL auto flash mode is recommended when using a camera compatible with TTL auto flash.

# 6 Repeating (RPT) flash operation

## What is Repeating flash operation

In Repeating flash operation, the Speedlight fires repeatedly during a single exposure, creating stroboscopic multiple-exposure effects. This operation is useful when shooting fast-moving subjects. When using cameras compatible with CLS, the SU-800 controls the flash output of the remote flash units (such as the SB-910, SB-900, SB-800), which are divided into three groups (A, B, and C), independently for each group.

- Be sure to read the user's manual of the Speedlight in use.

### Usable Speedlight

SB-910, SB-900, SB-800, SB-700, SB-600

## Notes on Repeating flash operation

- The SB-R200 cannot be used.
- Setting the flash units in group A or B to fire or cancel is not possible using the [A↔B] select button. Use the flash mode setting.
- Be sure to use fresh batteries and allow enough time for the flash to recycle between each repeating flash session.
- Also, because of the slower shutter speeds, use of a tripod is recommended to prevent camera/flash shake.

## Items to be set in Repeating flash operation

The following items can be set on the SU-800 in Repeating flash operation.

- Channel number (1, 2, 3, 4)
- Group name (A, B, C)
- Setting the flash units in each group to fire or cancel
- Manual flash output level, the frequency and the number of repeating flashes per frame

## Settings in the Repeating flash operation

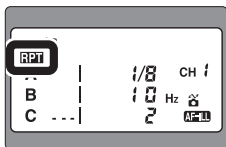

Display in Repeating flash operation

Set the Commander/Close-up select switch on the SU-800 to Commander function. Then, press and hold down the [SEL](FUNC.) button for approx. 2 seconds to toggle between the Repeating and Commander flash operations.

- Confirm that the RPT is displayed.

## 6 Repeating (RPT) flash operation

### Setting a channel number on the SU-800

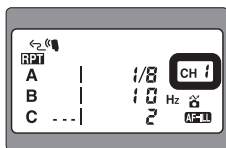

Press the [SEL](FUNC.) button on the SU-800 to display the channel number (blinking). Press the [◀] or [▶] button to change the channel number. Press the [SEL](FUNC.) button once again and the channel number will stop blinking. The last channel number to blink is the one that has been set automatically.

- Select one of the four available channels. The same channel number is set for all Groups A, B and C.

### Setting a group and a channel number on the Speedlight

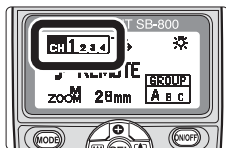

Display when using the SB-800

Set the same channel number as set on the SU-800.

- Refer to your Speedlight user's manual for specific information on settings.

### Setting the flash mode on each group

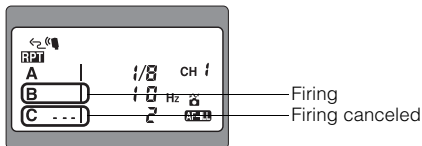

Press the [SEL](FUNC.) button to display the group (blinking). Press the [MODE] button to set the group to fire or to cancel.

## Setting the flash output level, the frequency (Hz), and the number of repeating flashes per frame

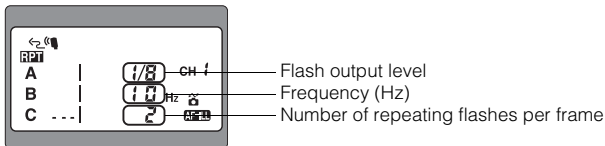

Set the same manual flash output level, frequency, and number of repeating flashes per frame for each group.

Press the [SEL](FUNC.) button to display the items to be set (blinking). Press the [◀] or [▶] button to change the values to be set. Press the [SEL](FUNC.) button once again and the value will stop blinking. The last value to blink is the one that has been set automatically.

- Continuously pressing the [◀] or [▶] button quickly increases or decreases the value.
- The item blinks during adjustment and stops after blinking six times unless an adjustment is made. The last value to blink is the one that has been set automatically.

### **☑ Determining the flash output level, the frequency (Hz), and the number of repeating flashes per frame**

#### **Flash output level**

- Manual flash output level can be set in 1 step increment or decrement from M1/8 to M1/128. (Default setting is M1/8.)

#### **Frequency**

- Frequency (Hz) represents the number of times the flash fires per second. The frequency can be set from 1 to 100. (Default setting is 10.)

#### **Number of repeating flashes per frame**

- The number of repeating flashes can be set from 1 to 90. (Default setting is 2.)
- The actual maximum number of repeating flashes per frame becomes lower than the one set as the shutter speed increases or the number of flashes per second decreases because the Speedlight fires during a single exposure.
- The maximum number of repeating flashes per frame varies depending on the frequency and flash output level. For more details, refer to your Speedlight user's manual.

# 7 Auto FP High-Speed Sync

Available with compatible cameras. You cannot set the Auto FP High-Speed sync mode on the SU-800 or SB-R200 directly, but must set it on the camera.

High-Speed flash synchronization at your camera's highest shutter speed is now possible. In this mode, the Auto FP High-Speed Sync mode is automatically set when the shutter speed exceeds the camera's sync shutter speed. This is useful when you want to use a wider aperture to achieve shallow depth of field to blur the background.

- Available flash modes are i-TTL, Auto Aperture flash, and Manual flash.

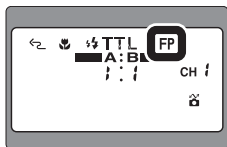

## Usable flash shooting distance ranges in Auto FP High-Speed Sync using the SB-R200 (in TTL mode) (m/ft)

ISO \ Aperture	25	50	100	200	400	800	1600
<b>f/1.4</b>	0.6-2.3/2.0-7.5	0.6-3.3/2.0-11	0.6-4.6/2.0-15	0.6-6.5/1.9-21.3	0.8-9.2/2.7-30.2	1.1-13/3.8-43	1.6-18/5.3-60
<b>f/2</b>	0.6-1.6/2.0-5.3	0.6-2.3/2.0-7.5	0.6-3.3/2.0-11	0.6-4.6/2.0-15.1	0.6-6.5/1.9-21.3	0.8-9/2.7-30	1.1-13/3.8-43
<b>f/2.8</b>	0.6-1.1/2.0-3.8	0.6-1.6/2.0-5.3	0.6-2.3/2.0-7.5	0.6-3.3/2.0-10.7	0.6-4.6/2.0-15.1	0.6-6.5/1.9-21	0.8-9/2.7-30
<b>f/4</b>	0.6-0.8/2.0-2.7	0.6-1.1/2.0-3.8	0.6-1.6/2.0-5.3	0.6-2.3/2.0-7.5	0.6-3.3/2.0-10.7	0.6-4.6/2.0-15	0.6-6.5/1.9-21
<b>f/5.6</b>	0.6-0.6/2.0-1.9	0.6-0.8/2.0-2.7	0.6-1.1/2.0-3.8	0.6-1.6/2.0-5.3	0.6-2.3/2.0-7.5	0.6-3.3/2.0-11	0.6-4.6/2.0-15
<b>f/8</b>	—	0.6-0.6/2.0-1.9	0.6-0.8/2.0-2.7	0.6-1.1/2.0-3.8	0.6-1.6/2.0-5.3	0.6-2.3/2.0-7.5	0.6-3.3/2.0-11
<b>f/11</b>	—	—	0.6-0.6/2.0-1.9	0.6-0.8/2.0-2.7	0.6-1.1/2.0-3.8	0.6-1.6/2.0-5.3	0.6-2.3/2.0-7.5
<b>f/16</b>	—	—	—	0.6-0.6/2.0-1.9	0.6-0.8/2.0-2.7	0.6-1.1/2.0-3.8	0.6-1.6/2.0-5.3
<b>f/22</b>	—	—	—	—	0.6-0.6/2.0-1.9	0.6-0.8/2.0-2.7	0.6-1.1/2.0-3.8
<b>f/32</b>	—	—	—	—	—	0.6-0.6/2.0-1.9	0.6-0.8/2.0-2.7



## In Manual flash mode

In Auto FP High-Speed Sync in Manual flash mode, the SB-R200's flash output level may be extremely low when the manual flash output level is set to a low value. However, this is not a malfunction. Flash output level may also vary depending on the subject matter conditions.

### Guide number in Auto FP High-Speed Sync using the SB-R200 (m/ft)

Flash output level	ISO sensitivity						
	25	50	100	200	400	800	1600
<b>M1/1</b>	1.4/4.6	2.0/6.5	2.8/9.2	4.0/13.1	5.6/18.5	8.0/26.2	11.3/37.1
<b>M1/2</b>	1.0/3.2	1.4/4.6	2.0/6.5	2.8/9.2	4.0/13.1	5.6/18.5	8.0/26.2
<b>M1/4</b>	0.7/2.3	1.0/3.2	1.4/4.6	2.0/6.5	2.8/9.2	4.0/13.1	5.6/18.5
<b>M1/8</b>	0.5/1.6	0.7/2.3	1.0/3.2	1.4/4.6	2.0/6.5	2.8/9.2	4.0/13.1
<b>M1/16</b>	0.3/1.1	0.5/1.6	0.7/2.3	1.0/3.2	1.4/4.6	2.0/6.5	2.8/9.2
<b>M1/32</b>	0.2/0.8	0.3/1.1	0.5/1.6	0.7/2.3	1.0/3.2	1.4/4.6	2.0/6.5
<b>M1/64</b>	0.1/0.5	0.2/0.8	0.3/1.1	0.5/1.6	0.7/2.3	1.0/3.2	1.4/4.6

- The guide number in Auto FP High-Speed Sync above is applicable when the shutter speed is set at 1/500 sec.
- The guide number in Auto FP High-Speed Sync above varies according to shutter speed. For example, when the shutter speed changes from 1/500 sec. to 1/1000 sec., the guide number decreases by 1 EV. This means that the higher the shutter speed, the lower the guide number.

## 8 Flash Value Lock (FV Lock)

Available with compatible cameras. You cannot set the FV Lock function on the SU-800 or SB-R200 directly. Set it on the camera.

Flash Value, or “FV,” is the amount of flash exposure for the subject.

Using FV Lock with compatible cameras, you can lock in the appropriate flash exposure for the main subject. This flash exposure remains locked in, even if you change the aperture or composition, or zoom the lens in and out.

- Available flash modes are i-TTL and Auto Aperture flash.

# Flash operation using various accessories

---

This section describes flash operation using various accessories.

Be sure to read your camera user's manual for specific information on camera settings and functions.

- 
- 1** Flash shooting with colored gel filters
  - 2** Flash shooting with the Extreme Close-Up Positioning Adapter SW-11
  - 3** Flash shooting with the Diffuser SW-12 and Flexible Arm Clip SW-C1
  - 4** Flash shooting with Speedlight Stand AS-20

# 1 Flash shooting with colored gel filters

The Color Filter Set SJ-R200 (for SB-R200 package) includes two filters for balancing the color of light: the FL-G1 for taking flash pictures under fluorescent light and the TN-A1 for use with incandescent/tungsten light, and the BLUE and RED filters for adding special colors to a scene.

- The optional Color Filter Set SJ-2 contains a total of 20 filters in 8 models of colored gel filters (p. 123).

## Example I



### Triple-light flash operation (with a colored gel filter)

One SB-R200 unit with a colored gel filter behind the subject is bounced off the back wall to emphasize the simple whiteness of the background.

The main SB-800 illuminates the subject from the front and the SB-600 provides strong light from behind to accentuate the subject to create impressive rim-lighting on her hair.

I-1

### Flash setup

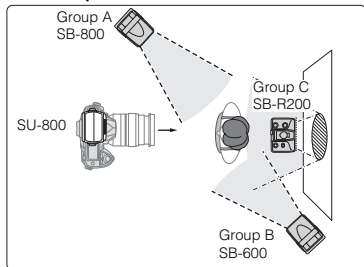

- Camera: D70
- Lens: AF-S DX Zoom-Nikkor 18-70mm f/3.5-4.5G IF-ED
- Group A: SB-800 (TTL)
- Group B: SB-600 (TTL)
- Group C: SB-R200 (M)

I-3 example in "Close-up Speedlight Photography Examples" was taken in dual-light flash operation with two different colored gel filters. I-2 was taken using triple-light flash operation without a colored gel filter. I-4 was taken in dual-light flash operation without a colored gel filter.

## Example H



### Dual-light flash operation

Two SB-R200 units with red and blue colored gel filters (provided) are bounced off the wall and directly from the top to add colors to the scene.

H-3

### Flash setup

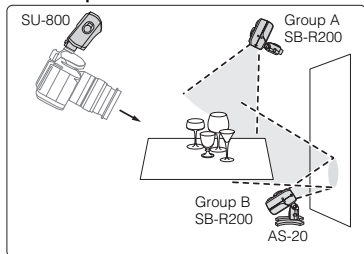

- Camera: D70
- Lens: AF-S DX Zoom-Nikkor 18-70mm f/3.5-4.5G IF-ED
- Group A: SB-R200 (TTL)
- Group B: SB-R200 (TTL)

H-2 and H-5 examples in "Close-up Speedlight Photography Examples" were taken under the same conditions as with H-3.

## ● **Balancing light from the flash**

---

With digital cameras, if you shoot flash pictures under fluorescent light with the camera's white balance set to "Flash," the main subject illuminated by the flash will look normal. However, the background will come out green. To compensate, use the FL-G1 (green gel filter) to convert the light coming from the flash to the same color as fluorescent light, then adjust the camera's white balance to "Fluorescent." Follow a similar procedure when shooting flash pictures under incandescent/tungsten illumination using the TN-A1 filter. In this case, set the white balance to "Incandescent."

- Available with digital cameras featuring white balance. You cannot set the white balance on the Speedlight. Choose an appropriate white balance setting on your digital camera. For more details, see your camera user's manual.

## ● **Using colored filters for adding special colors to a scene.**

---

Colored gel filters can be used to add specific colors to create various renderings of a scene.

- Adjust your digital camera's white balance (if available) to "Flash" for the most effective results.

## ● **Notes on using colored gel filters**

---

- Colored gel filters are consumable items. When they fade in color or deteriorate, purchase the optional Color Filter Set SJ-2.
- Do not use these filters when taking pictures with repeating flash, as the heat can damage them.
- The heat generated from the flash head can deform color filters. However, this will not affect their performance.
- There is no difference between the front and back of a colored gel filter.
- Scratches on the filters will have no effect on performance unless the filters fade in color.
- The amount of exposure compensation printed on each filter is provided as a guide only. Be sure to make test shots to determine the actual amount of compensation required.
- To remove dust or dirt, wipe the filter lightly with a soft, clean cloth.

# 1 Flash shooting with colored gel filters

## How to use colored gel filters

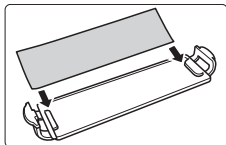

- 1 Insert the colored gel filter in the Color Filter Holder SZ-1.

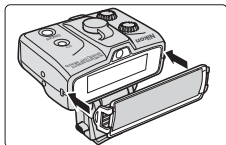

- 2 Attach the SZ-1 to the SB-R200.



- 3 Adjust the white balance setting on your digital camera, then shoot.
  - For details on test firing, refer to page 88.

## Using colored gel filters

Purpose	Gel filter	Adjust the camera's white balance to:
Balances the color of light from the flash to match that of fluorescent light	FL-G1	Fluorescent
Balances the color of light from the flash to match that of incandescent or tungsten light	TN-A1	Incandescent
Creates interesting effects by changing the light from the flash to a different color	Colored gel filters	Flash

## 2 Flash shooting with the Extreme Close-Up Positioning Adapter SW-11

With the Extreme Close-Up Positioning Adapter SW-11, you can curve the SB-R200's flash light toward the optical axis to create lighting effects when taking close-up shots.

- When using the SW-11, the lens-to-subject distance should be kept to within 15 cm (5.9 in.). If the distance exceeds this, irregular flash lighting may occur.
- Use of a Micro-NIKKOR lens is recommended with the SW-11.

### Example G

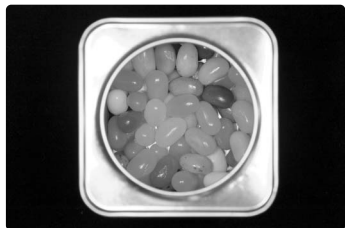

### G-4

### Flash setup

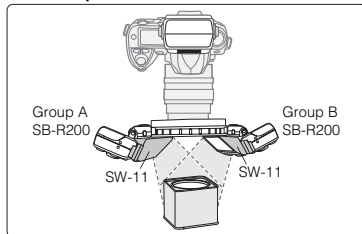

### Dual-light flash operation (with the SW-11)

Two SB-R200 units are used with the Extreme Close-Up Positioning Adapter SW-11 attached over both units. As the flash light is curved toward the optical axis, extremely vivid color images can be created while sufficient background illumination is guaranteed.

- Camera: D70
  - Lens: AF Micro-Nikkor 60mm f/2.8D
  - Group A: SB-R200 (TTL)
  - Group B: SB-R200 (TTL)
- G-5 example in "Close-up Speedlight Photography Examples" was taken without using the SW-11.

## Using the Extreme Close-Up Positioning Adapter SW-11

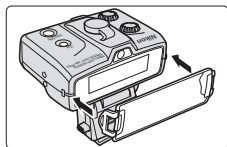

- 1** Attach the Color Filter Holder SZ-1 to the SB-R200's flash head.

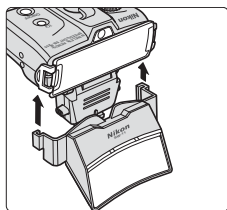

- 2** Place the SW-11 over the SZ-1. Slide the SW-11 aligning the grooves on both sides of the SZ-1 from its underside to attach.

## 2 Flash shooting with the Extreme Close-Up Positioning Adapter SW-11

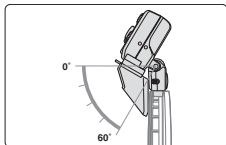

- 3 Tilt the SB-R200's flash head down 60° toward the optical axis.

### **Using the Extreme Close-Up Positioning Adapter SW-11 effectively**

---

Use the SW-11 when taking flash pictures at close distance for more effective results. Be sure to tilt the flash head by 60° toward the optical axis.



# 3 Flash shooting with the Diffuser SW-12 and Flexible Arm Clip SW-C1

By attaching the provided Nikon Diffuser SW-12 over the flash head, you can diffuse the SB-R200's flash light even more, creating extremely soft light with virtually no shadows.

## Example C

C-1



### Dual-light flash shooting (with Diffuser SW-12)

The Diffuser SW-12 is used to diffuse the light from the flash and soften shadows in order to enhance the detail of the cake, allowing the rendering of more natural-looking shadows that express the softness and freshness of the cake as compared with flash operation without using the Diffuser SW-12.

### Flash setup

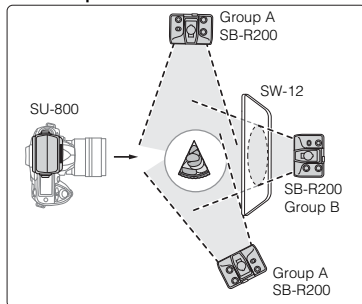

- Camera: D70
  - Lens: AF Micro-Nikkor 60mm f/2.8D
  - Group A: SB-R200 (TTL)
  - Group B: SB-R200 (TTL)
- C-4 example in "Close-up Speedlight Photography Examples" was taken under the same conditions as was C-1. C-2 and C-5 were taken without using the Diffuser SW-12. C-3 was taken using a single built-in flash.

## Example E

E-1



### Dual-light flash shooting (with Diffuser SW-12)

Two SB-R200 units are used to illuminate the small subjects from both sides to bring out their delicate detail. Illumination from one SB-R200 with the Diffuser attached from the left creates a softened highlight and renders vivid colors.

### Flash setup

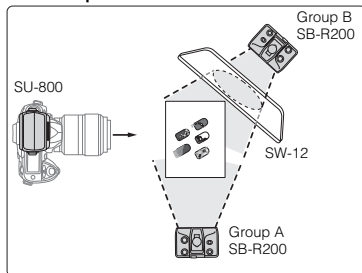

- Camera: D70
  - Lens: AF Micro-Nikkor 105mm f/2.8D
  - Group A: SB-R200 (TTL)
  - Group B: SB-R200 (TTL)
- E-2 example in "Close-up Speedlight Photography Examples" was taken without using the Diffuser SW-12.

## 3 Flash shooting with the Diffuser SW-12 and Flexible Arm Clip SW-C1

### Attachment of the Flexible Arm Clip SW-C1 to the SX-1

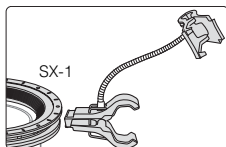

- 1 Align one of the Flexible Arm Clips with the Attachment Ring SX-1's Mounting groove.

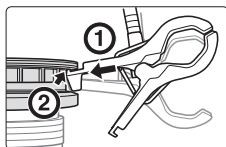

- 2 As shown in the diagram, insert the clip while aligning the SW-C1's Mounting groove with the front of the Attachment Ring SX-1's Mounting groove.

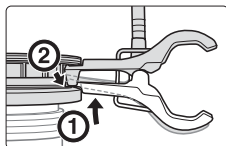

- 3 Holding one arm of the clip, open the other so that the stopper closes and slides into the SX-1, then release.
  - Ensure that the SW-C1's groove engages with the SX-1's groove.

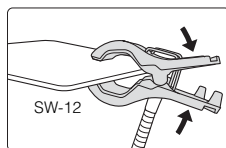

- 4 Grip the Diffuser SW-12 with the Flexible Arm Clip SW-C1.
  - As shown in the diagrams below, you can use the SW-C1 in two (long or short) ways depending on which direction the clip is mounted.

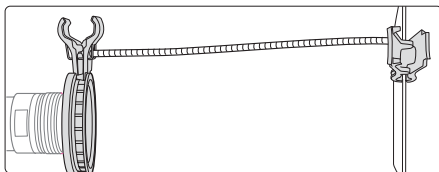
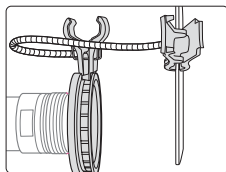

### Notes on using the SW-C1

- The maximum weight the SW-C1 can hold is approx. 70g (2.5 oz.).

# 4 Flash shooting with Speedlight Stand AS-20

Use the provided Speedlight Stand AS-20 to freely position the SB-R200. The Attachment Ring SX-1 can be attached to a tripod.

## Example H

H-1

## Flash setup

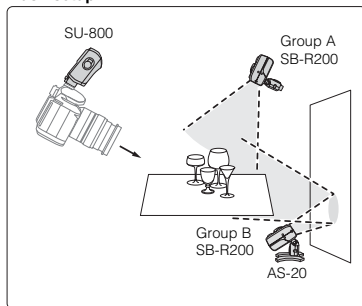

## Dual-light flash operation

When shooting clear glasses (H-4) with a single built-in flash unit, distinct shadows appear behind the subject, meaning the texture of the glass cannot be reproduced successfully. In this setup (H-1), the SB-R200 is placed on the right behind the subject using the AS-20 to bounce light off the rear wall. In addition, another SB-R200 is used from the top. The result is a successful rendering of the textures and contours of the glasses.

- Camera: D70
  - Lens: AF-S DX Zoom-Nikkor 18-70mm f/3.5-4.5G IF-ED
  - Group A: SB-R200 (TTL)
  - Group B: SB-R200 (TTL)
- H-4 example in "Close-up Speedlight Photography Examples" was taken using a single built-in flash.

Flash operation using various accessories

## Attachment of the SB-R200 to the AS-20

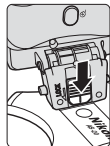
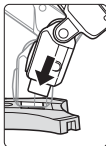

- 1** Slide the SB-R200's mounting foot into the AS-20's Speedlight mounting shoe and slide the Lock switch.

- Slide the Lock switch until it stops and make sure the red part can no longer be seen.
- To remove, slide the Lock switch and remove.

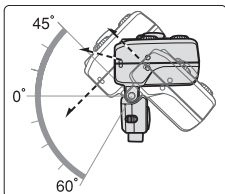

- 2** Adjust the SB-R200's flash head.

- The flash head of the SB-R200 tilts down to 60° and up to 45°. The flash head can be set at click stops every 15°.

## 4 Flash shooting with Speedlight Stand AS-20

### Attaching the AS-20 to the SX-1

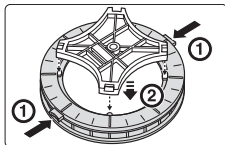

**1** Holding down the Mounting button on the SX-1, slide the AS-20 into the SX-1 as shown in the illustration. Remove your finger to secure it.

- Press both Mounting buttons firmly to attach.
- To remove AS-20 from the SX-1, press the Release button and remove.

### Setting up the SB-R200

Set up the SB-R200 flash units as shown in the diagram below.

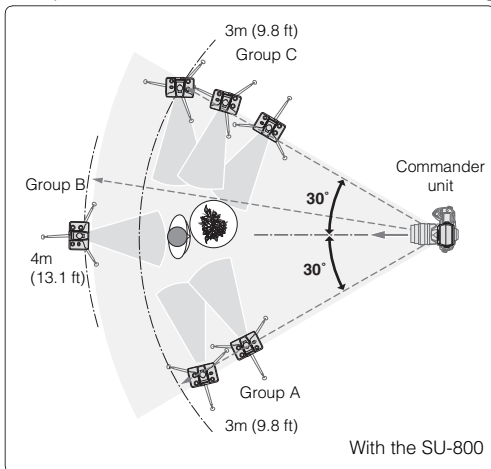

- In most cases, position the SB-R200 closer to the subject than the camera, so that light from the Commander flash unit (such as camera or Speedlight) can reach the light sensor of the remote flash unit(s). This is particularly necessary when holding a remote flash unit in your hand.
- Data communication cannot be performed properly if there is an obstacle between the Commander unit and the SB-R200.

- The effective shooting distance between the Commander and the SB-R200 varies depending on the Commander unit (such as a camera or Speedlight) in use. Refer to the user's manual of each product.
- Be sure to place all SB-R200 units that are set in the same group close together.
- Take care not to let light from the SB-R200 enter the camera lens directly or indirectly in TTL auto flash mode. Otherwise, the correct exposure cannot be obtained.
- There is no limit to the number of SB-R200 units that can be used together. However, if too much light from other SB-R200 units enters the light sensor of the Commander unit, correct operation may be impossible. In practice, the number of remote flash units should be limited to three for one group.
- Be sure to test fire after setting up all flash units (p. 88).

# Flash shooting using SLR cameras not compatible with CLS

---

Use the TTL Cord SC-30 (optional) to connect the SU-800 to the SB-R200 with SLR cameras not compatible with CLS.

- 
- 1** Overview of close-up flash operation (using cords)
  - 2** Procedures for close-up flash operation (using cords)

# 1 Overview of close-up flash operation (using cords)

When used with cameras not compatible with CLS, close-up flash operation is possible using the TTL Cord SC-30 (optional) to connect the SU-800 and SB-R200.

- D-TTL mode is available with digital SLR cameras not compatible with CLS, and TTL mode is available with film-based SLR cameras compatible with TTL auto flash mode. (p. 116)
- Close-up flash operation (using cords) is not possible with CLS-compatible cameras.

## Notes on performing close-up flash operation (using cords)

- As shown in the illustration, the SB-R200 connected to the right cord is assigned as Group A, and the SB-R200 connected to the left cord is assigned as Group B.
- When the SU-800 and SB-R200 are connected using cords, operations of [ON/Off] and Target light buttons on the SB-R200 become ineffective. The settings of the [GROUP] and [CHANNEL] select dials become invalid.
- The SB-R200 turns on when the SU-800 is turned on. The SB-R200 turns off when the SU-800 is turned off.

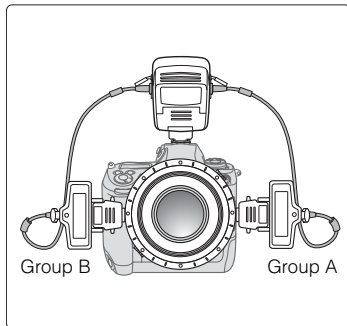

## Methods for setting up

### 1 Setting up the SU-800 and SB-R200.

Set up the SU-800 and SB-R200 in the same way as described in "Flash operation using the Nikon Close-up Speedlight Commander Kit R1C1" (p. 28).

- The same set-up is applicable when using the Speedlight Stand AS-20.

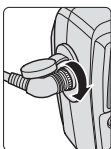
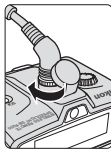

### 2 Connect the flash units using cords.

Use the optional TTL Cord SC-30 to connect between the TTL cord terminals of the SU-800 and SB-R200.

## Available flash modes

In close-up flash operation (using cords), the TTL BL, TTL and M flash modes are available. Every time you press the [MODE] button, the available flash mode changes.

- Available flash modes vary depending on the cameras and lenses in use.
- Unavailable flash modes will be skipped and do not appear when pressing the [MODE] button.
- The same flash mode is set for groups A and B.

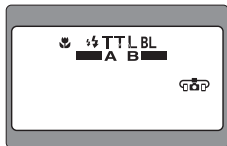

Display in TTL BL flash mode

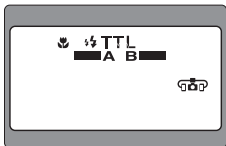

Display in TTL flash mode

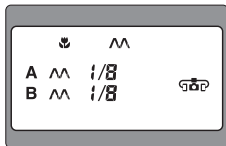

Display in M (manual) flash mode

## Items to be set in close-up flash operation (using cords)

The following items can be set in close-up flash operation.

- Flash mode (TTL BL, TTL, M)
- Flash firing/canceling for group A or B
- Flash output level compensation (in TTL mode)
- Manual flash output level (in M mode)

## 2 Procedures for close-up flash operation (using cords)

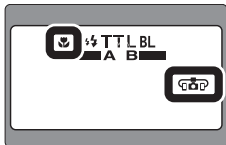

- 1** Turn on the camera and SU-800.  
After turning on the camera, press the [ON/OFF] button on the SU-800 to turn on the SU-800 and SB-R200.

- The red ready-lights on the SU-800 and SB-R200 come on when fully recycled.
- Make sure that Close-up mode and Using cords indicators appear on the LCD panel.

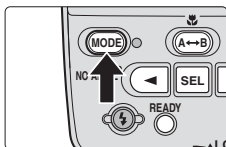

- 2** Setting the flash mode on the SU-800  
Press the [MODE] button on the SU-800 to set the flash mode to TTL BL, TTL or M.



- 3** Activating or canceling the SB-R200's flash firing  
Press the [A↔B] select button to set the remote flash units in Group A or B to fire or to cancel.

- A remote flash unit on the left as viewed from the SU-800's LCD panel is assigned to Group A, and a flash unit on the right is assigned to Group B.
- A flash canceled group indicator disappears.
- You cannot cancel flash firing for both Groups A and B.

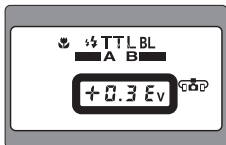

- 4** Setting the flash output level compensation (in TTL BL or TTL mode)

Press the [SEL](FUNC.), or [◀] or [▶] button to display the flash output level compensation value (blinking). Press the [◀] or [▶] button to increase or decrease the compensation value. Press the [SEL](FUNC.) button once again and the value will stop blinking. The last value to blink is the one that has been set automatically.

- The same value is set for both groups A and B.
- Flash output level compensation values can be set in 1/3 step increments or decrements from +3.0 to -3.0 EV.
- The values are displayed in decimal format, like 0.3 for 1/3, and 0.7 for 2/3.
- Pressing the [◀] or [▶] button continuously increases or decreases the value quickly.
- The compensation value blinks during adjustment and stops after blinking six times unless an adjustment is made. The last value to blink is the one that has been set automatically.
- If the flash output level compensation value is set 0.0, the display goes off.
- Being able to set flash output level compensation is dependant on camera in use.



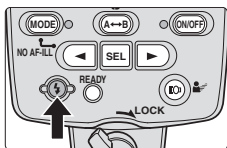

- 5** Press the [Test] button to test fire the flash units. Press the [Test] button on the SU-800 to test fire the SB-R200.
- Flash units fire at an M1/64 flash output in the TTL and at a specified output in the M (manual) mode.

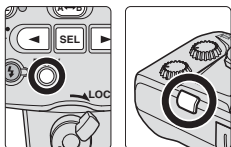

- 6** Compose a picture and shoot with flash. Confirm that the red ready-lights on the SU-800 and SB-R200 are on, then release the shutter.

**✔ If the red ready-light blinks immediately after shooting**

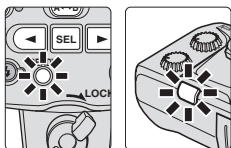

In TTL BL or TTL mode, when the SB-R200 flash has fired at its maximum output and underexposure may have occurred, the red ready-lights on the SU-800, SB-R200 and in the camera's viewfinder will blink for approx. 3 sec. (Depending on the camera in use, the ready-lights on the SU-800 and SB-R200 may blink, or only the ready-light in the camera's viewfinder.) To compensate, set a higher ISO sensitivity or use a wider aperture and reshoot.

**✏ In the M (manual) mode, set manual flash output level.**

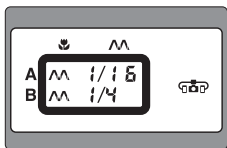

Press the [SEL](FUNC.) button to display the manual flash output level value (blinking). Press the [◀] or [▶] button to increase or decrease the value. Press the [SEL](FUNC.) button once again and the value will stop blinking. The last value to blink is the one that has been set automatically.

- Manual flash output level can be set separately for Group A and Group B.
- Manual flash output level can be set in 1 step increment or decrement from M1/1 to M1/64 output (M1/8 is preset when shipped from the factory.)
- Pressing the [◀] or [▶] button continuously increases or decreases the value quickly.
- Manual flash output level blinks during adjustment and stops after blinking six times unless an adjustment is made. The last value to blink is the one that has been set automatically.

## 2 Procedures for close-up flash operation (using cords)

### ● Checking the illumination before actually taking pictures (Modeling Illumination) in close-up flash operation (using cords)

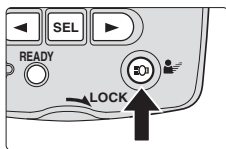

Press the Target Light button on the SU-800 and release within one second and the SB-R200's flash fires repeatedly at a reduced flash output level. This is useful for checking the illumination and the shadows cast on the subject before actually taking the picture.

### ● Using the Target Light (Focus-assist Illuminator) in close-up flash operation (using cords)

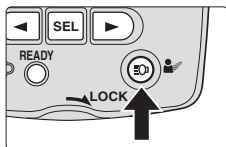

Press the Target Light button on the SU-800 for more than one second, the Target Light on the SB-R200 lights up.

- The Target Light illuminates for 60 seconds and goes out automatically. To cancel the illumination within 60 seconds, press the Target Light button again for more than one second.
- The Target Light also goes out when:
  - Releasing the shutter
  - Test firing
  - Firing the Modeling Illuminator
  - Pressing the [ON/OFF] button
- Pressing the Target light button on the SB-R200 is invalid.

# Reference information

---

This section covers available flash modes, troubleshooting, Speedlight care, Specifications, and optional accessories.

- 
- 1** Available flash modes
  - 2** Usable lenses with limited functions with the SB-R200
    - 3** Notes on continuous flash operation
    - 4** Optional accessories
    - 5** Tips on Speedlight care
    - 6** Notes on batteries
    - 7** Troubleshooting
    - 8** Specifications
    - 9** Index

# 1 Available flash modes

The TTL and M (manual) flash modes are available with the SU-800 and SB-R200. Use of TTL mode is recommended for normal flash photography.

- Be sure to read the user's manual of the camera in use.

## TTL auto flash mode

In this mode, the flash illumination that is reflected back from the subject is detected by the camera's TTL auto flash sensor and the camera automatically controls the flash output level to give the correct exposure.

i-TTL mode is available with CLS-compatible cameras, D-TTL mode is available with digital SLR cameras not compatible with CLS, and TTL mode is available with cameras compatible with TTL auto flash mode. The following flash operations are available.

### TTL-BL flash (Automatic Balanced Fill-Flash)

Based on exposure measurements obtained by a Matrix metering system, the flash output level is automatically adjusted for a well-balanced exposure of the main subject and background.

### TTL flash

The main subject is correctly exposed regardless of background brightness. This is useful when you want to highlight the main subject or make exposure compensation.

### About the flash shooting distance range in the TTL auto flash mode

When the SB-R200 is used as a remote flash unit, the flash shooting distance range is 0.6m to 28m (2 to 92 ft) and varies depending on ISO sensitivity and lens aperture in use.

### Usable flash shooting distance range (m/ft)

ISO \ Aperture	25	50	100	200	400	800	1600
<b>f/1.4</b>	0.6-3.5/2.0-11.6	0.6-5.0/2.0-16	0.6-7.1/2.0-23	0.9-10.0/2.9-32.8	1.3-14.1/4.1-46.4	1.8-20/5.8-66	2.5-28/8.2-93
<b>f/2</b>	0.6-2.5/2.0-8.2	0.6-3.5/2.0-11.6	0.6-5.0/2.0-16	0.6-7.1/2.0-23.2	0.9-10.0/2.9-32.8	1.3-14/4.1-46	1.8-20/5.8-66
<b>f/2.8</b>	0.6-1.8/2.0-5.8	0.6-2.5/2.0-8.2	0.6-3.5/2.0-11.6	0.6-5.0/2.0-16.4	0.6-7.1/2.0-23.2	0.9-10.0/2.9-33	1.3-14/4.1-46
<b>f/4</b>	0.6-1.3/2.0-4.1	0.6-1.8/2.0-5.8	0.6-2.5/2.0-8.2	0.6-3.5/2.0-11.6	0.6-5.0/2.0-16.4	0.6-7.1/2.0-23	0.9-10.0/2.9-33
<b>f/5.6</b>	0.6-0.9/2.0-2.9	0.6-1.3/2.0-4.1	0.6-1.8/2.0-5.8	0.6-2.5/2.0-8.2	0.6-3.5/2.0-11.6	0.6-5.0/2.0-16	0.6-7.1/2.0-23
<b>f/8</b>	—	0.6-0.9/2.0-2.9	0.6-1.3/2.0-4.1	0.6-1.8/2.0-5.8	0.6-2.5/2.0-8.2	0.6-3.5/2.0-11.6	0.6-5.0/2.0-16
<b>f/11</b>	—	—	0.6-0.9/2.0-2.9	0.6-1.3/2.0-4.1	0.6-1.8/2.0-5.8	0.6-2.5/2.0-8.2	0.6-3.5/2.0-11.6
<b>f/16</b>	—	—	—	0.6-0.9/2.0-2.9	0.6-1.3/2.0-4.1	0.6-1.8/2.0-5.8	0.6-2.5/2.0-8.2
<b>f/22</b>	—	—	—	—	0.6-0.9/2.0-2.9	0.6-1.3/2.0-4.1	0.6-1.8/2.0-5.8
<b>f/32</b>	—	—	—	—	—	0.6-0.9/2.0-2.9	0.6-1.3/2.0-4.1

## ■ Determining proper flash operation distance range in dual-light close-up flash operation with lens in use

Use the table below to determine applicable apertures at the desired reproduction ratio. The proper apertures depend on ISO sensitivity, lens focal length, and desired reproduction ratio.

The reproduction ratio is defined as the image-on-film size to the actual subject size. For example, if a 5 cm-long subject is photographed, and its length on film is 1 cm, then the reproduction ratio is 1:5.

ISO sensitivity								Lens focal length							
ISO								AF/AF-S Micro-NIKKOR lenses							
25	50	100	200	400	800	1600		60mm f/2.8D	60mm f/2.8G ED	105mm f/2.8D	105mm f/2.8G IF-ED	200mm f/4D IF-ED	DX 85mm f/3.5G ED		
		2.8	4	5.6	8	11									
		2.8	4	5.6	8	11	16								
2.8	4	5.6	8	11	16	22		1:1	1:1	1:1	1:1	1:1	1:1		
4	5.6	8	11	16	22	32		1:1	1:1	1:1	1:1	1:1	1:1		
5.6	8	11	16	22	32	45		1:1	1:1	1:1	1:1	1:1	1:1		
8	11	16	22	32	45	64		1:1	1:1	1:1	1:1	1:1	1:1		
11	16	22	32	45	64			1:1	1:1	1:1	1:1	1:1	1:1		
16	22	32	45	64				1:1	1:1	1:1	1:1	1:1	1:1		
22	32	45	64					1:1	1:1	1:1	1:1	1:1	1:1		
32	45	64						1:1	1:1	1:1	1:1	1:1	1:1		
45	64							1:1	1:1	1:1	1:1	1:1	1:1		
64								1:1	1:1	1:1	1:1	1:1	1:1		

Effective f-number

Reproduction ratio **1:1** **1:3** **1:5** **1:10**

Applicable apertures

- The above data are applicable when two SB-R200 units are attached to the Attachment Ring SX-1 on both sides with flash output level ratio set to 1:1, and two flash units are fired.
- More natural-looking illumination may be possible by tilting the SB-R200 toward the optical axis, depending on reproduction ratios and the lens in use. Adjust the SB-R200 to illuminate the center of the picture angle using the Target light.
- When taking pictures at reproduction ratios other than those listed above, determine the appropriate figures on the table above. For example, at a 1:2 reproduction ratio, refer to applicable aperture at 1:1 or 1:3.
- When the Extreme Close-Up Positioning Adapter SW-11 is used with the SB-R200, the flash light amount varies depending on reproduction ratios (increases when the shooting distance is approx. 15cm (5.9 in.) or less). Making test shots is recommended.
- The data in the table above are effective f-numbers. They are not apertures on the lens.

# 1 Available flash modes

## ☑ Aperture to set on the lens and effective f-number

Effective f-numbers of close-up lenses such as Micro-NIKKOR lenses vary, while brightness of image on film decreases when reproduction ratio increases. The relationship between the reproduction ratio and the effective f-number is:

$$F_e = F (1 + M)$$

where  $F_e$  = Effective f-number (actual lens speed)

$F$  = Aperture to set on the lens

$M$  = Reproduction ratio

In TTL auto flash operation, the aperture value appearing on the LCD panel or in the camera's viewfinder is the effective f-number when a Micro-NIKKOR lens is mounted on the camera.

## ● M (manual) mode

In Manual flash photography, you select the aperture and flash output level. In this way, you can control the exposure and flash shooting distance when shooting subjects where the correct exposure is difficult to obtain in the TTL auto flash mode.

### Available flash output level

In close-up flash operation: M1/1 to M1/64.

In Commander flash operation: M1/1 to M1/128.

In Repeating flash operation: M1/8 to M1/128.

### Determining the aperture and flash output level in the M (manual) mode

In the Manual mode, use the following guide number and the equation to calculate the aperture, flash output level, and shooting distance to obtain the correct exposure.

- The guide number (GN at ISO 100; m/ft) indicates the amount of light generated by the flash. The larger the number, the greater the flash output.

### To calculate the correct aperture

Calculate the correct aperture by using this equation:

$$f/\text{stop (aperture)} = \text{Guide number (GN at ISO 100; m/ft)} \times \text{ISO sensitivity factor} \div \text{Shooting distance (m/ft)}$$

- Set the same aperture for both the SU-800 and the camera or lens.

Guide number of the SB-R200 is 10/33 (ISO 100, m/ft)

### ISO sensitivity factors

For sensitivities other than ISO 100, multiply the guide number by the factors shown in the table below.

ISO	25	50	100	200	400	800	1600	3200	6400
Factors	0.5	0.71	1	1.4	2	2.8	4	5.6	8

## ● Auto Aperture (AA) flash mode

---

The SU-800's built-in sensor measures the flash illumination reflected from the subject and controls the flash output in combination with data automatically transmitted from the camera and lens to the SU-800, including the ISO sensitivity value and exposure compensation value as well as the aperture and focal length of the lens.

- Auto Aperture flash is available only when the SB-910, SB-900 or SB-800 is used as a remote flash unit. (A warning indicator appears if the SB-R200, SB-700 or SB-600 receives an Auto Aperture flash mode signal.)
- If the flash mode is set to Auto Aperture flash while a non-CPU lens is mounted, the AA mode display blinks as a warning, and the flash units will not fire.
- For flash shooting distance range in the Auto Aperture flash mode, read the user's manual of your Speedlight.

### **☑ Notes on performing flash operation in the Auto Aperture flash mode**

---

When taking a distant subject, underexposure may occur even though the subject is within the flash shooting distance range. Use of the TTL auto mode is recommended with cameras compatible with TTL auto flash.

## 2 Usable lenses with limited functions with the SB-R200

### Maximum number of SB-R200 units to be attached to the front of the lens

#### AF NIKKOR lenses

Lens	Adapter rings	Max. number of flash units
AF-S NIKKOR 24mm f/1.4G ED	SY-1-77	Up to 2
AF Nikkor 28mm f/1.4D	SY-1-72	Up to 4
AF-S NIKKOR 28mm f/1.8G	SY-1-67	Up to 2
AF-S NIKKOR 35mm f/1.4G	SY-1-67	Up to 2
AF Micro-Nikkor 60mm f/2.8D	UR-5 + SY-1-72	Up to 4
AF-S Micro NIKKOR 60mm f/2.8G ED	SY-1-62	Up to 4
AF Nikkor 85mm f/1.4D IF	SY-1-77	Up to 4
AF-S NIKKOR 85mm f/1.4G	SY-1-77	Up to 2
AF DC-Nikkor 105mm f/2D	SY-1-72	Up to 4
AF Micro-Nikkor 105mm f/2.8D	SY-1-62	Up to 4
AF-S VR Micro-Nikkor 105mm f/2.8G IF-ED	SY-1-62	Up to 4
AF DC-Nikkor 135mm f/2D	SY-1-72	Up to 4
AF Nikkor 180mm f/2.8D IF-ED	SY-1-72	Up to 4
AF Micro-Nikkor 200mm f/4D IF-ED	SY-1-62	Up to 4
AF-S Nikkor 300mm f/4D IF-ED	SY-1-77	Up to 4
AF-S Zoom-Nikkor 17-35mm f/2.8D IF-ED	SY-1-77	Up to 4
AF Zoom-Nikkor 18-35mm f/3.5-4.5D IF-ED	SY-1-77	Up to 2
AF-S NIKKOR 24-70mm f/2.8G ED	SY-1-77	Up to 2
AF-S Zoom-Nikkor 28-70mm f/2.8D IF-ED	SY-1-77	Up to 2
AF-S VR Zoom-Nikkor 70-200mm f/2.8G IF-ED	SY-1-77	Up to 4
AF-S NIKKOR 70-200mm f/2.8G ED VR II	SY-1-77	Up to 4
AF Zoom-Nikkor 80-200mm f/2.8D ED	SY-1-77	Up to 4

#### DX NIKKOR lenses

Lens	Adapter rings	Max. number of flash units
AF-S DX NIKKOR 35mm f/1.8G	SY-1-52	Up to 2
AF-S DX Micro NIKKOR 85mm f/3.5G ED VR	SY-1-52	Up to 4
AF-S DX Zoom-Nikkor 12-24mm f/4G IF-ED	SY-1-77	Up to 4
AF-S DX Zoom-Nikkor 17-55mm f/2.8G IF-ED	SY-1-77	Up to 2
AF-S DX Zoom-Nikkor 18-70mm f/3.5-4.5G IF-ED	SY-1-67	Up to 2



## Manual focus NIKKOR lenses

Lens	Adapter rings	Max. number of flash units
PC-E NIKKOR 24mm f/3.5D ED*1	SY-1-77	Up to 2
Nikkor 35mm f/1.4	SY-1-52	Up to 2
PC-E Micro NIKKOR 45mm f/2.8D ED*1	SY-1-77	Up to 2
Micro-Nikkor 55mm f/2.8	SY-1-52	Up to 4
Nikkor 85mm f/1.4	SY-1-72	Up to 2
PC Micro-Nikkor 85mm f/2.8D*1	SY-1-77	Up to 2
PC-E Micro NIKKOR 85mm f/2.8D*1	SY-1-77	Up to 2
Nikkor 105mm f/1.8	SY-1-62	Up to 2
Nikkor 105mm f/2.5	SY-1-52	Up to 2
Micro-Nikkor 105mm f/2.8	SY-1-52	Up to 2
Nikkor 135mm f/2	SY-1-72	Up to 2
Nikkor 135mm f/2.8	SY-1-52	Up to 2
Nikkor 180mm f/2.8 ED	SY-1-72	Up to 2
Micro-Nikkor 200mm f/4 IF	SY-1-52	Up to 4

\*1 Using the PC-E NIKKOR 24mm f/3.5D ED, PC-E Micro NIKKOR 45mm f/2.8D ED, PC-E Micro NIKKOR 85mm f/2.8D or PC Micro-Nikkor 85mm f/2.8D set at the Tilt and/or Shift position is not recommended.

## Usable lenses but vignetting occurs depending on focal length

Note that vignetting may occur with these lenses depending on focal length.

Lens	Focal length at which vignetting occurs	
	Nikon DX format digital SLR cameras	35mm (135) format Nikon film-SLR cameras and Nikon FX format digital SLR cameras
AF-S NIKKOR 24mm f/1.4G ED	No vignetting	All settings
AF Nikkor 28mm f/1.4D	No vignetting	All settings
AF-S Zoom-Nikkor 17-35mm f/2.8D IF-ED	No vignetting	24mm or shorter
AF Zoom-Nikkor 18-35mm f/3.5-4.5D IF-ED	No vignetting	24mm or shorter
AF-S NIKKOR 24-70mm f/2.8G ED	No vignetting	28mm or shorter
AF-S Zoom-Nikkor 28-70mm f/2.8D IF-ED	No vignetting	35mm or shorter
AF-S DX Zoom-Nikkor 12-24mm f/4G IF-ED	15mm or shorter	—
AF-S DX Zoom-Nikkor 17-55mm f/2.8G IF-ED	20mm or shorter	—
AF-S DX Zoom-Nikkor 18-70mm f/3.5-4.5G IF-ED	18mm	—

## ☑ When using the SB-R200 attached to the lens

Be careful not to knock and damage the lens when using the SB-R200 units attached to the front of the lens.

### 3 Notes on continuous flash operation (in close-up flash operation (using cords))

To prevent the SB-R200 from overheating, allow the SB-R200 to cool down for at least 10 minutes after the maximum number of continuous firings have been performed as shown in the table below.



**CAUTION**

**Do not exceed the maximum number of continuous firings**, as this may cause the flash head to overheat and can result in burns and damage to the flash panel and body.

#### Max. number of continuous firings

Flash mode	Max. number of continuous firings (at 6 frames/sec.)
TTL auto flash	15
Manual flash (Flash output level: M1/1, M1/2)	
Manual flash (Flash output level: M1/4 to M1/64)	30



**CAUTION**

**Be careful when replacing batteries after continuous flash use**, because batteries may generate heat during continuous flash photography.

#### **Synchronization during continuous flash operation**

It is possible to take up to the number of frames during continuous operation as shown in the table below.

#### **SB-R200's maximum number of frames during continuous flash operation (at six frames per sec.)**

Flash output level			
1/8	1/16	1/32	1/64
Up to 4	Up to 8	Up to 16	Up to 30

## 4 Optional accessories

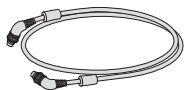

### TTL Cord SC-30

Close-up flash operation (using cords) is possible in the TTL mode with the optional TTL Cord SC-30 to connect the SU-800 and the SB-R200.

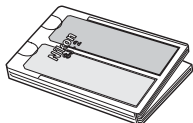

### Color Filter Set SJ-2

A total of 20 filters in 8 models are provided.

- FL-G1 (for fluorescent light)
- FL-G2 (for fluorescent light)
- TN-A1 (for incandescent/tungsten light)
- TN-A2 (for incandescent/tungsten light)
- BLUE
- YELLOW
- RED
- AMBER

Colored gel filters are consumable items and subject to gradual deterioration in color due to the heat generated by the flash firing. Therefore, it is recommended to check and replace these filters when necessary.

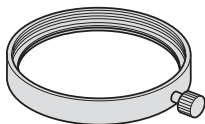

### Dedicated Adapter Ring UR-5

With an AF Micro-Nikkor 60mm f/2.8D lens, attach the Attachment Ring SX-1 to the lens using the Adapter Ring UR-5 and Adapter Ring SY-1-72.

# 5 Tips on Speedlight care



## WARNING

Never use thinner, benzene, or other active agents for cleaning the Speedlight, as this may damage the Speedlight or cause it to catch fire. Using these agents may also impair your health.

## Cleaning

- Use a blower brush to remove dirt and dust from the Speedlight and clean it with a soft, clean cloth. After using the Speedlight near saltwater, wipe the flash unit with a soft, clean cloth moistened slightly with tap water to remove the salt, then dry it with a dry cloth.
- On rare occasions, the LCD may turn on or turn dark due to static electricity. This is not a malfunction. The display will soon return to normal.
- Do not drop the Speedlight or knock it on a hard surface, as this may damage its precision mechanisms. Do not apply strong pressure to the LCD panel.

## Storage

- Store the Speedlight in a cool, dry place to prevent malfunctions due to high humidity, as well as the growth of mold or mildew.
- Keep the Speedlight away from chemicals such as camphor or naphthalene. Avoid exposing the Speedlight to magnetic waves from televisions or radios.
- Do not use or leave the Speedlight in locations subject to high temperatures such as near a heater or stove, as this may cause damage.
- When not using the Speedlight for more than two weeks, be sure to remove the battery to prevent damage due to battery leakage.
- Take the Speedlight out once a month, insert the battery, and fire the unit several times to reform the capacitor.
- When the Speedlight is stored together with a desiccant, renew the desiccant occasionally.

## Operating location

- An extreme temperature change can cause condensation to form inside the Speedlight. When exposing the Speedlight to high temperatures from very low temperatures, or vice versa, place it inside an airtight container such as a plastic bag. Leave it inside the container for a while before gradually exposing the Speedlight to the outside temperature.
- Avoid exposing the Speedlight to strong magnetic or radio waves from televisions or high voltage power transmission towers, as this may cause it to malfunction.

# 6 Notes on batteries

## Usable batteries

### Use CR123A (3V) lithium batteries.

- Do not use any other type of batteries.
- Non-rechargeable. Never attempt to recharge these batteries in a battery charger. Otherwise, they may explode.
- Depending on battery specifications, when these batteries become hot, the safety circuits are activated, cutting off power. This often occurs when the flash unit is operated in the repeating flash mode. Battery power will recover when the temperature returns to normal.

## Notes on handling batteries

- When installing the battery, turn off the power of the Speedlight and never reverse the polarity of the batteries.
- If the battery terminals become soiled, remove dirt and smudges before use, as these may cause damage.
- If exhausted batteries are used at low temperatures, the Commander or Speedlight units may not work properly.
- When taking photographs in low temperatures, use fresh batteries, and keep a set of spares in a warm place (e.g. a coat pocket).
- Battery power tends to weaken as the temperature drops. At low temperatures, flash capacity decreases and recycling takes longer. Battery power will recover if they are not used and allowed to return to normal temperature.
- Do not throw used batteries into a fire. Do not short circuit, disassemble, heat or recharge a battery.

## Replacing the battery

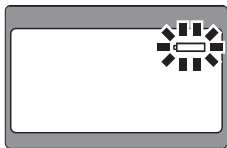

The low battery-power indicator blinks when the Commander SU-800's ready-light does not come on within approx. 30 seconds of the power being turned on or after the flash has fired.

- Replace the battery.

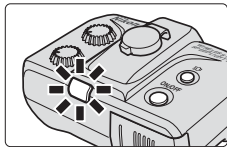

When the SB-R200's battery power is weak, the green ready-light blinks after the power has been turned on or after the flash has fired.

- Replace the battery.

# 7 Troubleshooting

If the Speedlight malfunctions or a warning indication appears on the Speedlight's LCD panel, use the following items to determine the cause of the problem before taking your Speedlight to a Nikon service center for repair.

## Warning indications in the Commander SU-800 and the Remote Speedlight SB-R200

### In the close-up mode

#### Using cords warning



With CLS-compatible cameras, if the SU-800 and the SB-R200 are connected using cords, the "Err" indicator appears, and the "Using cords" indicator blinks.

#### Incompatible camera warning



The SU-800 cannot be used with COOLPIX-Series cameras other than COOLPIX P7100, P7000 and P6000. If used, the Wireless flash indicator blinks as a warning.

#### Incorrect connection to the SB-R200 using cords



With cameras not compatible with CLS, if the SU-800 and the SB-R200 are not correctly connected using cords, the "Using cords" indicator blinks.

- If both groups A and B are not correctly connected, "Err" indicator is displayed, and "Using cords" indicator blinks.

## Communication error warning with the SB-R200

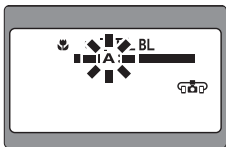

If, due to a weak battery etc., data communication fails with either group A or B when using a camera not compatible with CLS, even though the SU-800 and the SB-R200 are properly connected, the corresponding group (A or B) indicator blinks. The "Using cords" indicator does not blink.

- If data communication fails with both groups A and B, the "Err" indicator is displayed, and the "Using cords" indicator blinks.



## In the Commander mode

### Using cords indicator



If the SU-800 is mounted on cameras not compatible with CLS, the Commander function does not work. Warning indicators appear if the Commander mode is set.

- When the SU-800 is mounted on CLS-compatible cameras, the SU-800 and SB-R200 will not work if these units are connected using cords. Warning indicators will appear.

## Incompatible camera warning



The SU-800 cannot be used with COOLPIX-Series cameras other than COOLPIX P7100, P7000 and P6000. If used, the Wireless flash indicator blinks as a warning.

## Incompatible lens warning

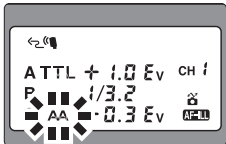

When used in combination with a non-CPU lens, if the flash mode is set to Auto Aperture flash (AA), the AA mode indicator blinks to warn you that the flash units in that group will not fire.

## 7 Troubleshooting

### Flash malfunction warning

While the SB-R200 is used as a wireless remote flash unit, the red ready-light rapidly blinks four times and stops for 0.5 sec. This cycle is repeated six times if the flash unit receives a signal such as Non-TTL auto flash or Repeating flash.

### Problems with the Commander SU-800 and the Remote Speedlight SB-R200

Problem	Cause	Solution
The SB-R200 does not fire.	The SB-R200's power is off.	Confirm that the red ready-light comes on.
	Different channel numbers are set to the Commander (SU-800) and the SB-R200.	Set the same channel number to both flash units.
	Different group names are set to the Commander (SU-800, etc.) and SB-R200.	Set the same group to both flash units.
	Control signal from the Commander (SU-800, etc.) does not reach the light sensor window of the SB-R200.	Rearrange the position of the SB-R200 so that the light from the Commander reaches the SB-R200.
Vignetting occurs	The shutter speed set is faster or slower than the flash sync speed.	Set the shutter speed to the flash sync speed.
	Vignetting occurs with a wide angle lens	Change the lens' focal length.
Underexposure occurs	Light from the flash unit enters the camera lens or light sensor window on the flash unit.	Rearrange the position of the camera or flash unit so that the light does not enter the lens or light sensor window.
AF-Assist Illuminator does not turn on.	The SU-800 is set to close-up mode.	In the close-up mode, the AF-Assist Illuminator on the SU-800 does not illuminate. However, camera's AF-assist illuminator turns on.
	Camera's focus mode is set to "AF-C".	Set camera's focus mode to "AF-S".



## ● Ready-light warning inside the camera's viewfinder

---

Problem	Solution
The ready-light inside camera's viewfinder blinks when the SU-800 is mounted on cameras not compatible with CLS and the flash mode is set to TTL in close-up flash operation (using cords).	Set the flash mode to M (manual).

## ● A note on microcomputer-controlled Speedlights

---

The Speedlight incorporates a microcomputer to control flash operations. In rare cases, the Speedlight may not work properly even after a fresh battery is properly installed. If this happens, replace the battery while the Speedlight's power is turned on.

### Warning

- Batteries should not be exposed to excessive heat such as strong sunshine, fire, etc.
- Dry batteries should never be recharged in a battery charger.
- Do not expose the Speedlight to water as this may result in electric shock or cause the unit to catch on fire.

# 8 Specifications

## Wireless Speedlight Commander SU-800

<b>Transmission mode</b>	Infrared-pulse emitting communication using a flash discharge tube
<b>Transmission range</b>	Approx. 20m (66 ft) for SB-910/SB-900/SB-800/SB-700/SB-600 Approx. 4m (13 ft) for SB-R200 at normal settings
<b>No. of channels</b>	4
<b>No. of groups</b>	3
<b>No. of transmissions</b>	Approx. 1200
<b>Transmission interval</b>	Approx. 1 sec.
<b>Flash light wavelength</b>	Approx. 800 to 1000nm (infrared ray)
<b>Flash coverage</b>	Approx. 60° (vertical), Approx. 78° (horizontal)
<b>Display</b>	LCD, ready-light
<b>AF-Assist Illuminator</b>	Approx. 10m (33 ft) at center area using a 50mm f/1.8 lens
<b>Power source</b>	One 3V CR123A lithium battery
<b>Weight</b>	Approx. 160g (5.6 oz.)
<b>Dimensions (W x H x D)</b>	Approx. 68 x 96 x 58mm (2.7 x 3.8 x 2.3 in.)

*These performance specifications are applicable when a fresh battery is used at normal temperatures (20°C/68°F).*

*Specifications and design are subject to change without notice.*

## Wireless Remote Speedlight SB-R200

<b>Electronic construction</b>	Automatic Insulated Gate Bipolar Transistor (IGBT) and series circuitry (for wireless remote flash unit only)
<b>Guide number</b>	10/33 (ISO 100, m/ft), 14/46 (ISO 200, m/ft)
<b>Angle of coverage</b>	Covering light distribution of 24mm lens; 60° (vertical) and 78° (horizontal)
<b>Flash mode</b>	i-TTL, D-TTL, TTL (film-based SLR cameras) M (manual)
<b>Min. recycling time (approx.)</b>	6 sec.
<b>Min. number of flashes* / interval between full flash output and ready light on</b>	290/6-30 sec.  *When firing the Speedlight at full output once every 30 seconds.
<b>Bounce capability</b>	Flash head tilts down (toward the optical axis) to 60° with click stops at every 15°, or up to 45° (in the opposite direction) with click stops at every 15°.
<b>Flash duration</b>	Approx. 600µs
<b>Mounting foot</b>	Dedicated shoe for Attachment Ring SX-1 or Speedlight Stand AS-20
<b>Target light</b>	White LED
<b>Display</b>	Ready-light
<b>Power source</b>	One CR123A (3V) lithium battery
<b>Weight</b>	Approx. 120g (4.2 oz.)
<b>Dimensions (W x H x D)</b>	Approx. 80 x 75 x 55mm (3.1 x 3.0 x 2.2 in.)

*These performance specifications are applicable when a fresh battery is used at normal temperatures (20°C/68°F).*

*Specifications and design are subject to change without notice.*

# 9 Index

- For Speedlight parts, icons etc. on the LCD panel, refer to “Speedlight parts, their functions, and accessories” (p. 18) and “SU-800’s LCD panel and icons” (p. 20).

## Symbol

[◀](left) button .....	19
[▶](right) button .....	19
[A→B] select button .....	19
[CHANNEL] select dial .....	35
[GROUP] select dial.....	36
[MODE] button .....	19
[ON/OFF] button .....	19
[SEL](FUNC.) button .....	19
i-TTL mode .....	116

## A

AF-ILL.....	91
AS-20 .....	24, 107
Accessories .....	99, 123
Adapter Ring.....	24
Advanced Wireless Lighting .....	26
AF-Assist Illuminator .....	91
Attachment Ring .....	24
Auto Aperture flash .....	119
Auto FP High-Speed Sync .....	96
Automatic Balanced Fill-Flash .....	21

## B

Batteries .....	125
-----------------	-----

## C

CLS .....	7
CLS-compatible cameras .....	20
Cameras compatible with CLS .....	13
Channel.....	21
Close-up flash operation (using cords).....	110
Close-up mode .....	65
Color Filter Holder .....	24
Color Filter Set.....	24, 123
Colored gel filters.....	100
Commander .....	82

Commander mode.....	79
Commander/Close-up select switch .....	58
Continuous flash shooting .....	122
Control button .....	19

## D

D-TTL mode .....	116
Dedicated Adapter Ring.....	123
Default settings.....	8
Diffuser .....	25, 105
Displays when blinking.....	22
Dual-light close-up flash operation.....	68

## E

Exposure meter off .....	57
Extreme Close-Up Positioning Adapter .....	24, 103
Extreme Close-Up Positioning Adapter for SB-R200.....	24, 103

## F

FV Lock flash .....	98
Flash head.....	23
Flash mode .....	116
Flash output level.....	95
Flash output level compensation.....	92
Flash output level compensation value .....	20
Flash output level ratio.....	20
Flash shooting distance range .....	116
Flexible Arm Clip .....	25
For your safety .....	2
Frequency.....	95

## G

Group.....	21
Guide number.....	118

<b>I</b>	
IR Panel for Built-in Flash.....	24
ISO sensitivity.....	117
ISO sensitivity factor .....	118
Icon .....	20

<b>L</b>	
LCD panel.....	20
LCD panel illuminator.....	22
Lock switch.....	31

<b>M</b>	
Manual mode.....	118
Master flash unit.....	26
Micro-NIKKOR lenses.....	13
Modeling illuminator.....	89
Mounting foot lock lever.....	29
Multiple flash operation.....	26

<b>N</b>	
NO AF-ILL .....	91
Nikon Close-up Speedlight Commander Kit R1C1.....	15
Nikon Close-up Speedlight Remote Kit R1.....	15
Nikon Creative Lighting System (CLS).....	7
Number of flashes.....	95

<b>R</b>	
R1.....	15
R1C1.....	15
Ready-light.....	18, 23
Recommended cameras .....	13
Recommended lenses.....	13
Remote flash unit .....	26, 82
Remote Speedlight .....	23
Repeating flash.....	93
Replace the battery.....	125

<b>S</b>	
SB-R200.....	23, 59
SC-30 .....	123
SG-3IR.....	24, 50

SJ-R200.....	24, 100
SU-800.....	18, 53
SW-11 .....	24, 103
SW-12 .....	25, 105
SW-C1.....	25, 106
SX-1 .....	24
SZ-1 .....	24
Shutter release button .....	32
Speedlight Stand .....	24, 107
Speedlight parts .....	18

<b>T</b>	
TTL cord .....	123
TTL cord terminal.....	110
TTL mode.....	116
Target light.....	90
Target light button .....	90
Test firing.....	88
Triple-light close-up flash operation.....	68
Two-button reset.....	19

<b>U</b>	
UR-5.....	123
Unusable lenses.....	14

<b>W</b>	
Warning indications .....	126
Wireless Remote Speedlight .....	23, 59
Wireless Speedlight Commander.....	18, 53
Wireless communication.....	20
Wireless multiple flash shooting .....	26

# **Nikon**

No reproduction in any form of this manual, in whole or in part (except for brief quotation in critical articles or reviews), may be made without written authorization from NIKON CORPORATION.